

**CCS Technical Documentation  
NHL-4/4U Series Transceivers**

**Service Software Instructions**

[This page left intentionally blank]

Table of Contents

	Page No
Quick Guide for Phoenix Service SW Installation .....	5
Phoenix Installation Steps in Brief .....	5
Phoenix Service SW .....	6
Before Installation .....	6
Startup .....	7
Dongle Driver Installation and Version Check .....	8
First Time Installation of Phoenix .....	9
Update Installation of Phoenix .....	12
How to Uninstall Phoenix .....	13
Data Package for Phoenix (Product Specific).....	15
Before installation .....	15
Installation of Phoenix Data Package (Product Specific) .....	16
How to Uninstall Data Package .....	19
How to Manage Connections .....	20
Manual Settings.....	21
How to Update Flash Support Files for FPS-8* and FLS-4* .....	23
Before Installation .....	23
Installing the Flash Support Files .....	23
How to Update The FPS-8* Flash Prommer SW .....	26
FPS-8 Activation and Deactivation.....	28
Activation .....	28
Deactivation .....	30
JBV-1 Docking Station SW .....	31
Before Installation .....	31
Installing SW Needed for the JBV-1 SW Update .....	32
Updating the JBV-1 Docking Station Software .....	36
Receiver tuning: Quick Guide for Tuning With Phoenix .....	39
General remarks .....	39
Service Tool Concept for RF Tuning Operations .....	40
Receiver Tuning: RX Channel Select Filter Calibration .....	42
RX Calibration .....	43
RX Band Filter Response Compensation .....	47
RX DTOS balance calibration .....	53
Transmitter tuning.....	56
TX Power Level Tuning .....	56
TX I/Q Tuning .....	61
Service Tool Concept For Baseband Tuning Operations.....	65
Service Concept for NHL-4* Baseband tunings .....	66
Baseband Tuning operations .....	67
Energy Management Tuning .....	67
LCD Contrast Tuning .....	69
Flashing Setup Instructions .....	71
POS (Point of Sale) Flash Concept .....	71
Module Jig Concept .....	72
JBV-1 Flash Concept .....	73
Service Concept .....	74
Parallel Flash concept .....	75

[This page left intentionally blank]

## Quick Guide for Phoenix Service SW Installation



### Phoenix Installation Steps in Brief

DCT-4 generation Test and Service Software is called "Phoenix"

These are the basic steps to install the Phoenix

- Install the Phoenix Service SW
- Install the Data Package for Phoenix (product specific data and flash update package)
- Manage connection settings (depends on the tools you are using)
- Update FPS-8 SW (if you use FPS-8)
- Activate FPS-8
- Update JBV-1 Docking Station SW (only when needed)

The flash update files are delivered with then Phoenix Data Package so unless you want to use certain version of this package, separate installation package is not needed anymore. If you want to use it, it should be installed after connection management, before FPS-8 update.

**Please refer to Service Manual and Technical Bulletins for more information concerning phone model specific service tools and equipment setup.**

## Phoenix Service SW

### Before Installation

- Check that a Dongle is attached to the parallel port of your computer.
- Download the installation package (e.g. **phoenix\_service\_sw\_a3\_03\_83\_005.exe**) to your computer (e.g. C:\TEMP)
- Close all other programs
- Run the application file (e.g. **phoenix\_service\_sw\_a3\_03\_83\_005.exe**) and follow instructions on the screen
- Administrator rights may be required to be able to install Phoenix depending on the Operating System
- If the dongle driver is installed or updated, you need to reboot your PC before the installation can continue.
- If uninstalling or rebooting is needed at any point, you will be prompted by the Install Shield program.

If at any point during installation you get this message, Dongle is not found and installation can't continue.

Possible reasons may be defective or too old PKD-1Dongle (five digit serial number Dongle when used with FPS-8 Prommer) or that the FLS-4S POS Flash Dongle is defective or power to it is not supplied by external charger.

Check the COM /parallel ports used first! After correcting the problem Installation can be restarted.

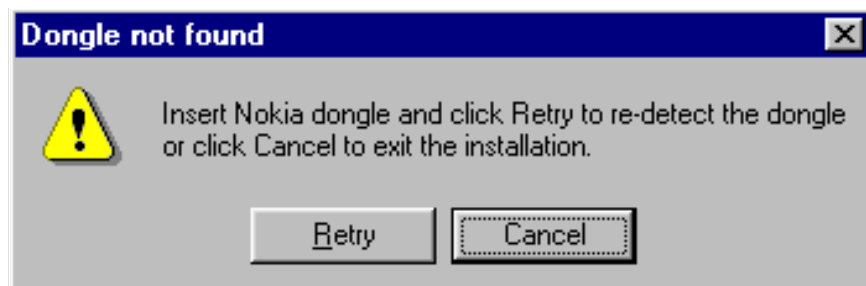

## Startup

Run the **phoenix\_service\_sw\_a3\_03\_83\_005.exe** to start installation.

When you choose "Next" the files needed for installation will be extracted. Kindly wait.

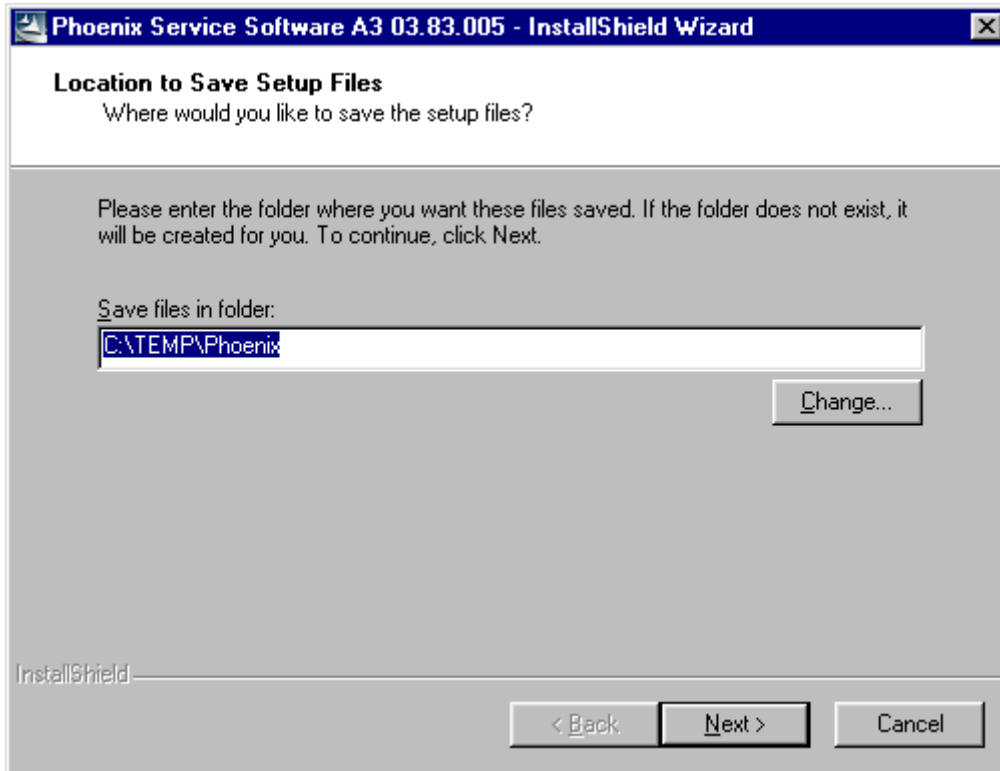

If the setup files are already extracted (left in the file system from previous installation) following dialog appears. Always click "Yes to All" to overwrite the existing setup files.

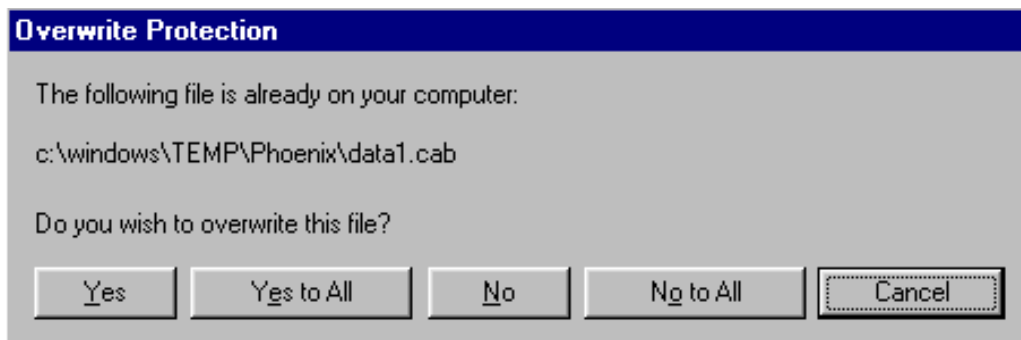

## Dongle Driver Installation and Version Check

If there is no previously installed Dongle driver, installation will take place...

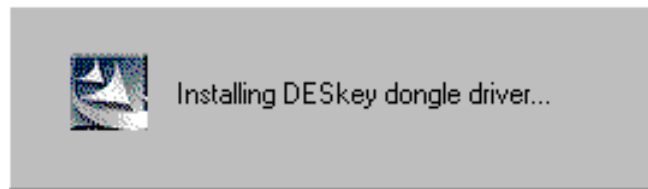

If the Dongle driver is installed and it is older than the latest supported version, the latest version will be installed when you choose "Yes". The latest version is always included in the latest Phoenix installation package.

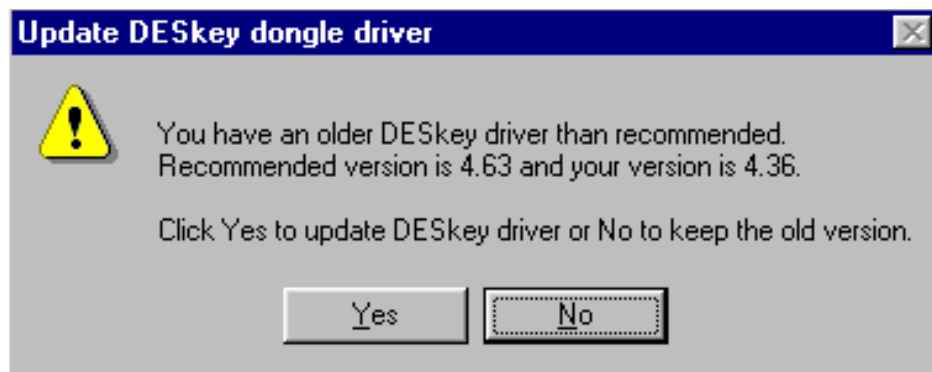

PC needs to be rebooted before installation can continue. Click "Yes" to reboot the PC.

Setup is restarted automatically after reboot.

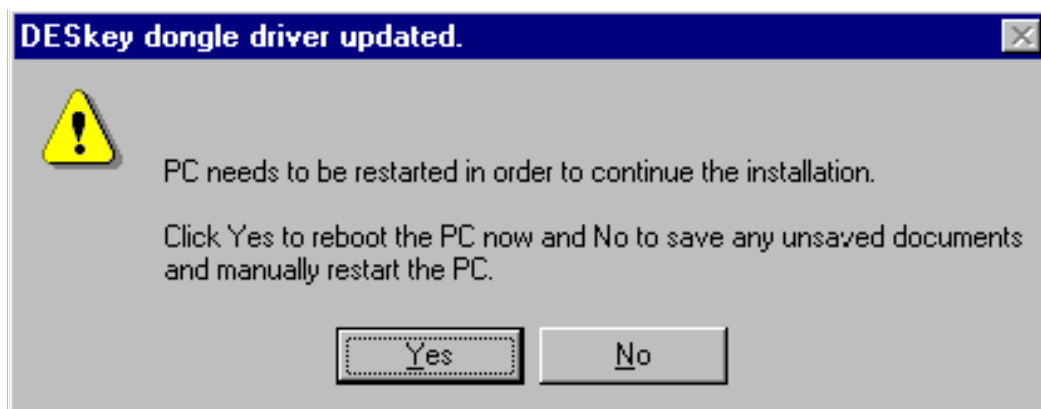



## First Time Installation of Phoenix

After Dongle driver installation / update (if needed) installation continues from this step. Click "Next" in Welcome dialog to continue.

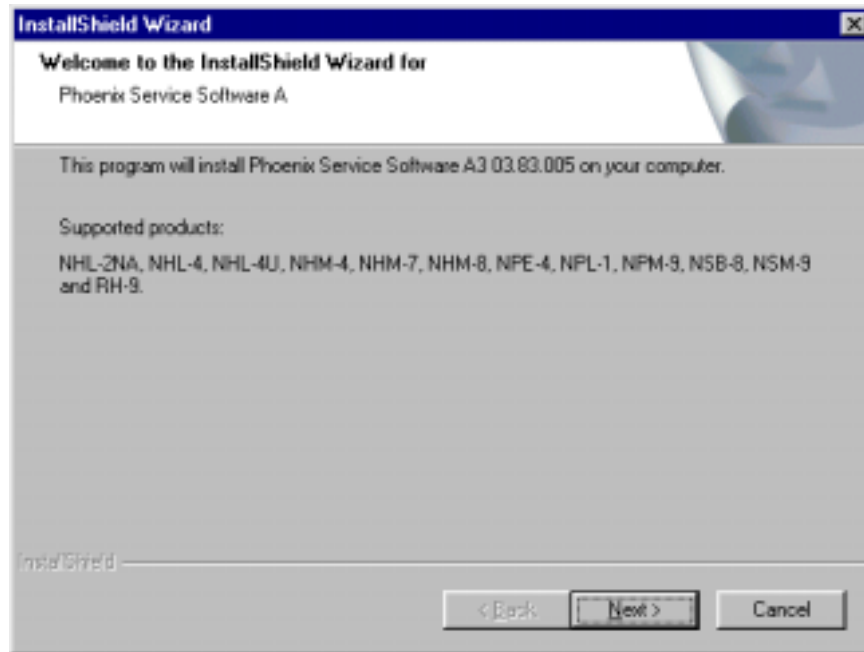

Choose the destination folder, it is recommended to use the default folder **C:\Program-Files\Nokia\Phoenix**.

Choose "Next" to continue. You may choose another location by selecting "Browse" (not recommended)

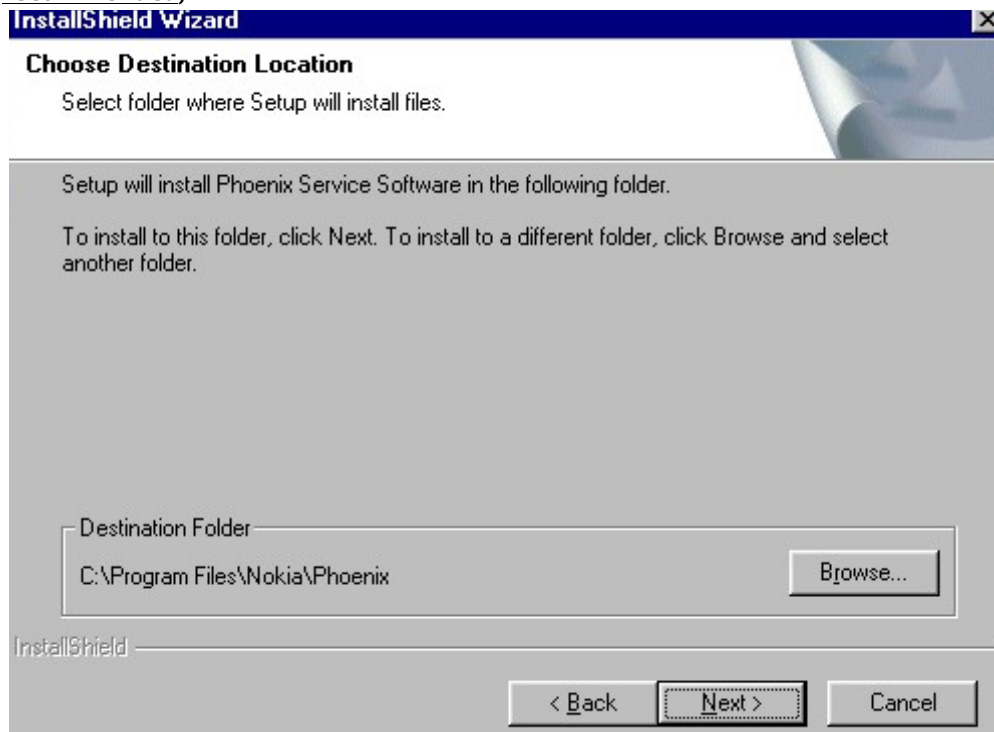

Setup copies the components, please wait.

Progress of the setup is shown. Please wait...

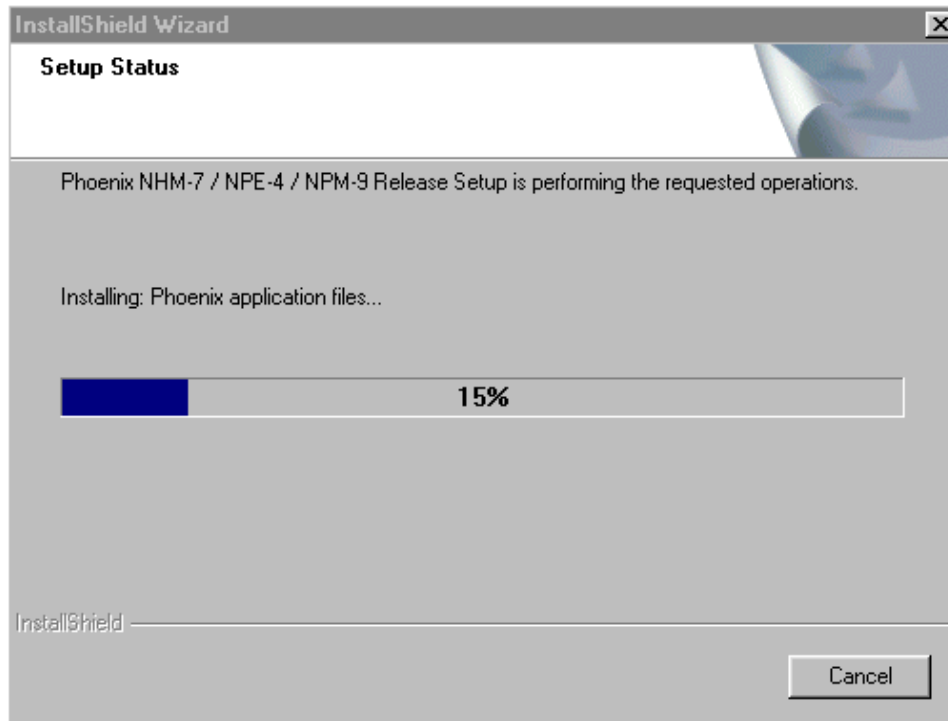

If restarting of your computer is needed the Install Shield Wizard will tell you about it.

Select "Yes..." to reboot the PC immediately and "No..." to reboot the PC manually.

Note that Phoenix doesn't work, if components are not registered. Click "Finish" to continue.

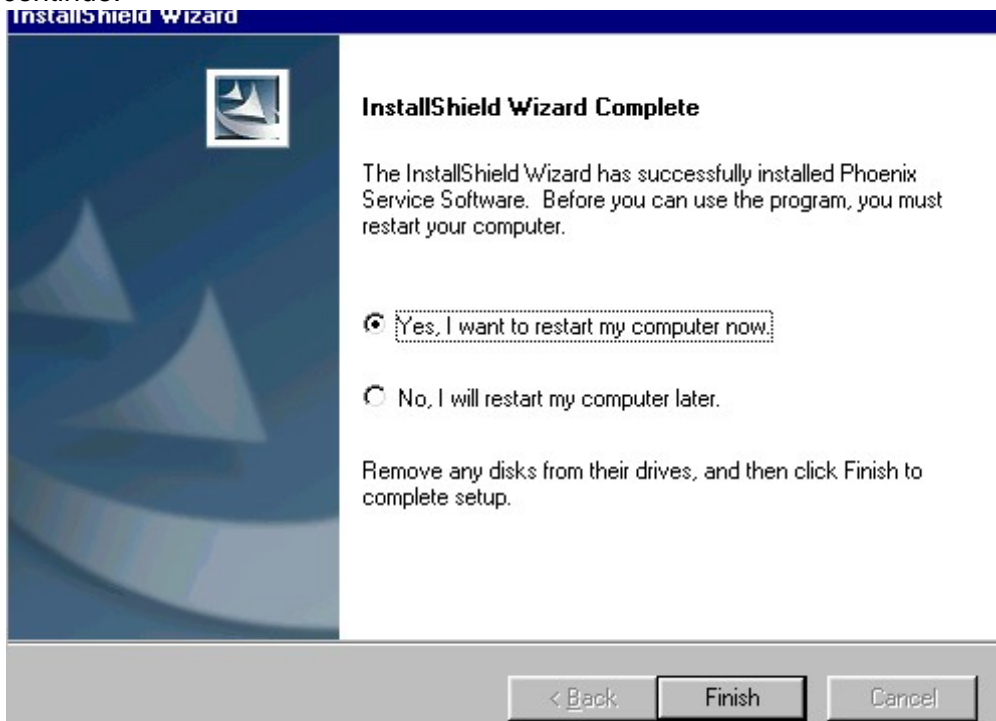

After the reboot components are registered and Phoenix is ready for use.

If reboot is not needed components are registered after copying them.

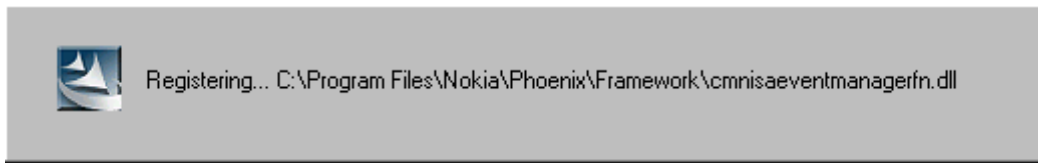

**If restarting of your computer is not needed, Click "Finish" to exit the setup.**

Phoenix is now ready for use.

**Now the installation of Phoenix Service SW is ready and it can be used after:**

- **Installing Phone model specific Phone Data Package for Phoenix**
- **Configuring the connections**
- **Updating the Flash Update Package files used with FPS-8\* and FLS-4\* tools**

## Update Installation of Phoenix

If you already have the Phoenix Service SW installed on your computer, sooner or later there will be need to update it when new versions are released.

Please note that very often the Phoenix Service SW and the Phone Specific Data Package for Phoenix come in pairs, meaning that certain version of Phoenix can only be used with certain version of Data Package. Always use the latest available versions of both. Instructions can be found in phone model specific Technical Bulletins.

To update the Phoenix you need to take exactly the same steps as when installing it for the first time.

- Download the installation package to your computer hard disk
- Close all other programs
- Run the application file (e.g. **phoenix\_service\_sw\_a3\_03\_83\_005.exe**)
- Dongle driver version will be checked and if need be, updated
- After reboot installation starts automatically
- Newer version of Phoenix will be installed

When you update the Phoenix from old to new version (e.g. update from 3.83.005 to 3.83.0055), the update will take place automatically without uninstallation

If you try update the Phoenix with the same version that you already have (e.g. 3.55 to 3.55) you are asked if you want to uninstall the version of Phoenix you have on your PC. Answer "OK" to uninstall Phoenix, "Cancel" if you don't want to uninstall.

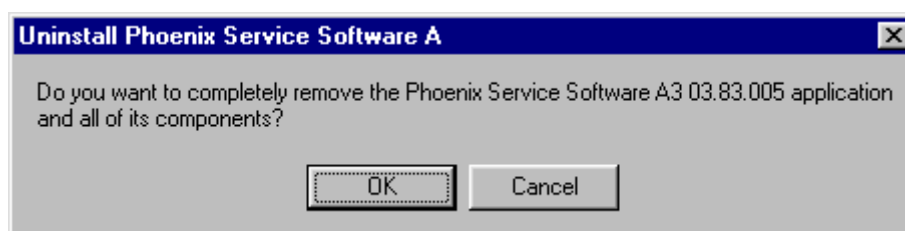

If you try to install an older version (e.g. downgrade from 3.83.005 to 3.83.005) installation will be interrupted.

*Always follow the instructions on the screen.*

## How to Uninstall Phoenix

Uninstallation can be done manually from Windows Control Panel - Add / Remove Programs.

Choose "Phoenix Service Software" and click "Add/Remove".

Choose "OK" to uninstall

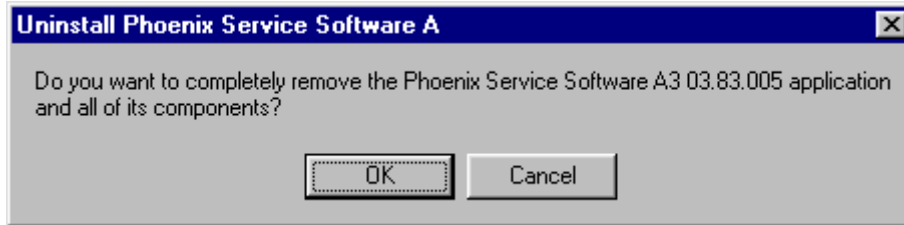

Progress of the uninstallation is shown.

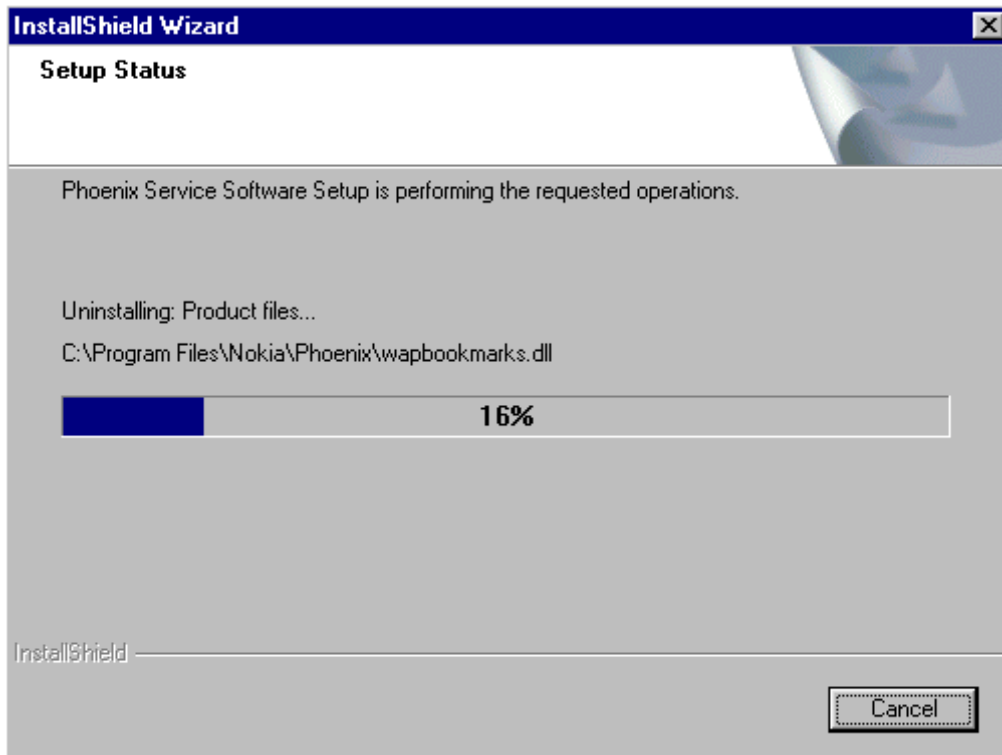

You may have to reboot the PC after uninstallation.

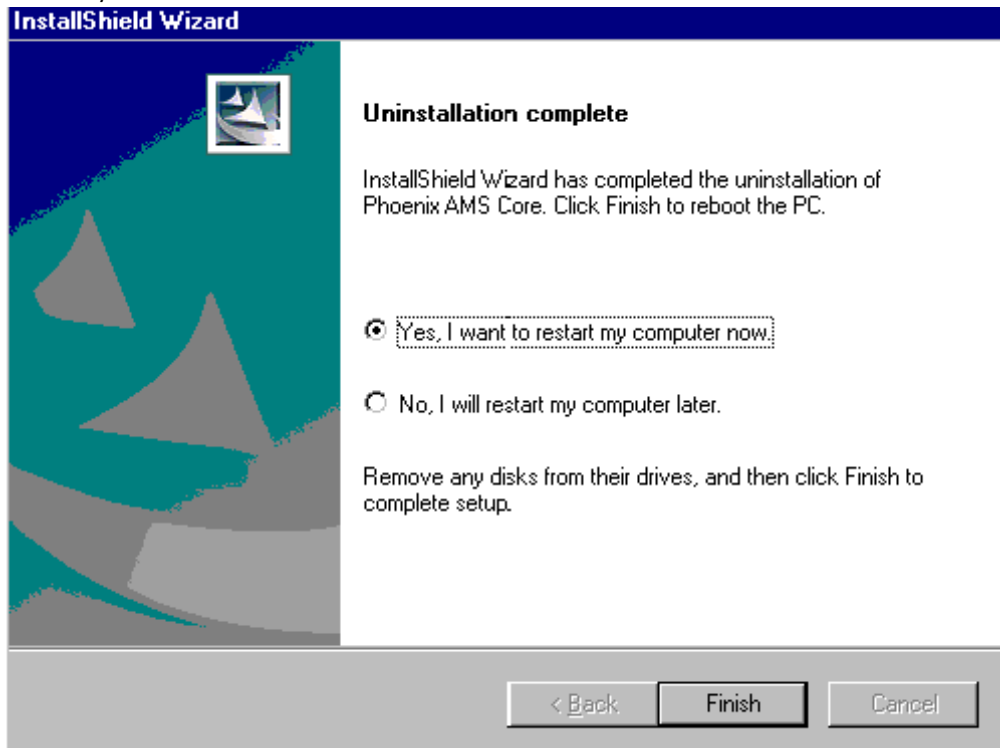

If restarting is not needed, the following dialog will appear:

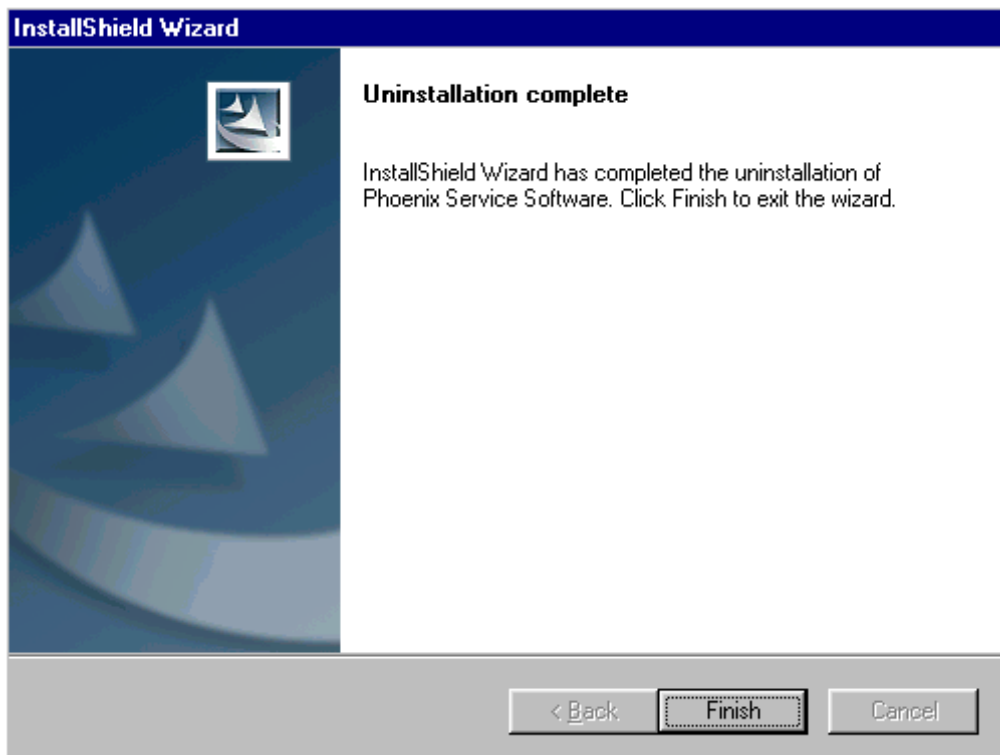

*Note!* If you have different product packages installed, components are uninstalled only if they are not included in other product packages.

## Data Package for Phoenix (Product Specific)

### Before installation

Product Data Package contains all product specific data to make the Phoenix Service Software and tools usable with a certain phone model.

It also includes the latest version of flash update package for FLS-4\* and FPS-8\*

- Check that the Dongle is attached to the parallel port of your computer.
- Install Phoenix Service SW
- Download the installation package (e.g. **nhl-4\_dp\_1.00.exe**) to your computer (e.g. C:\TEMP)
- Close all other programs
- Run the application file (e.g. **nhl-4\_dp\_1.00.exe**) and follow instructions on the screen

If you already have the Phoenix Service SW installed on your computer, sooner or later there will be need to update it when new versions are released.

Please note that very often the Phoenix Service SW and the Phone Specific Data Package for Phoenix come in pairs, meaning that certain version of Phoenix can only be used with certain version of Data Package. Always use the latest available versions of both. Instructions can be found in phone model specific Technical Bulletins.

## Installation of Phoenix Data Package (Product Specific)

Run the *nhl-4\_dp\_v\_1.00.exe* to start installation.

When you choose "Next" the files needed for installation will be extracted. Please wait...

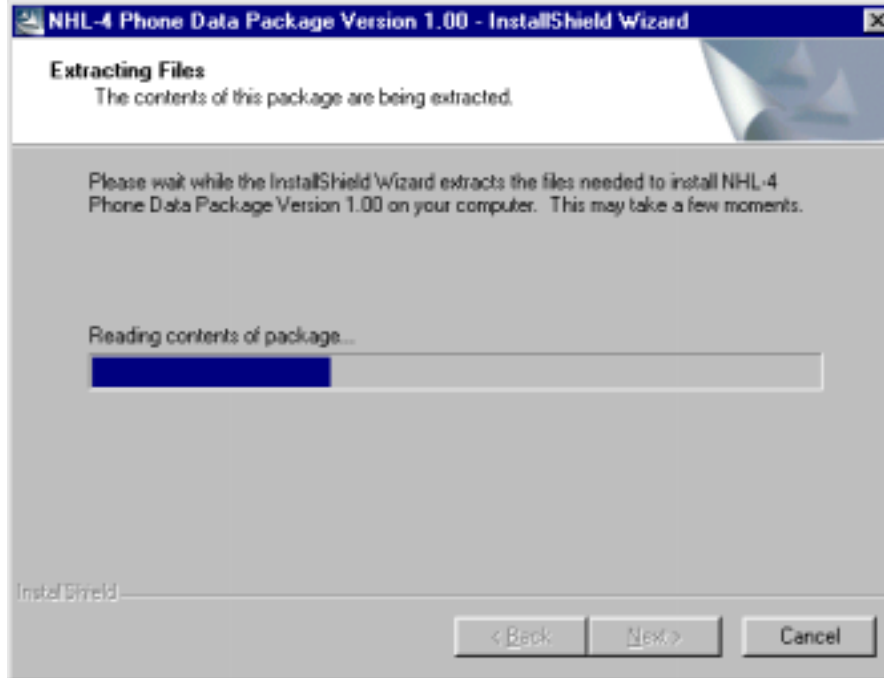

Choose "Next" to continue.

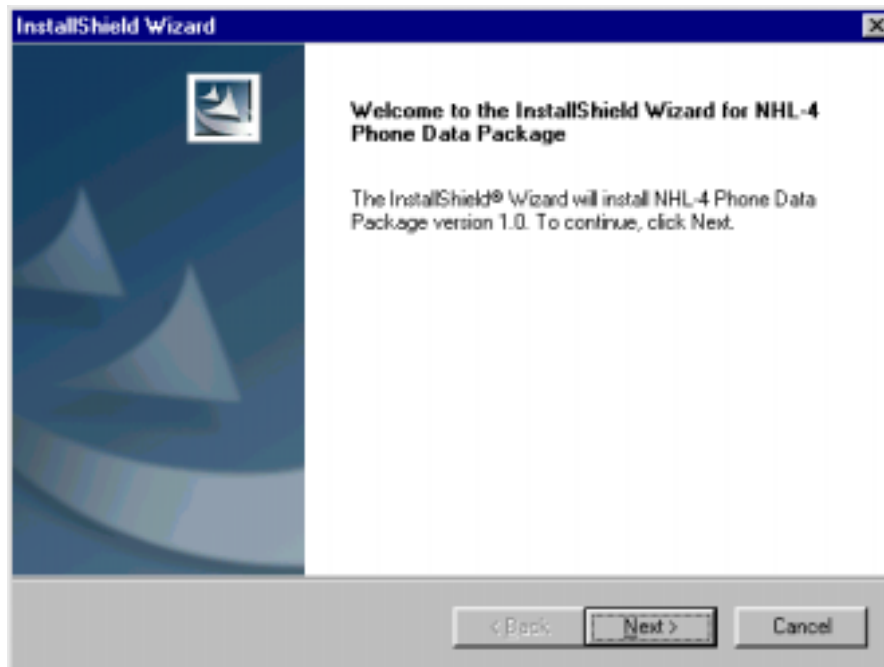

From this view you can see the contents of the Data Package.

**Read the text carefully.**



There should be information about the Phoenix version needed with this data package. Choose "Next".

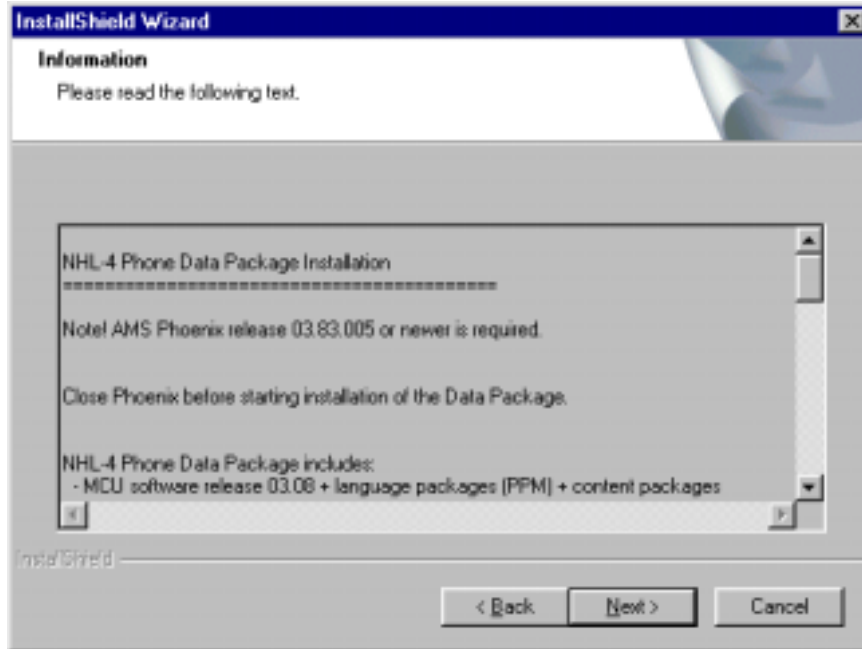

Confirm location and choose "Next" to continue.

Install Shield checks where the Phoenix application is installed and the directory is shown. Choose "Next" to continue.

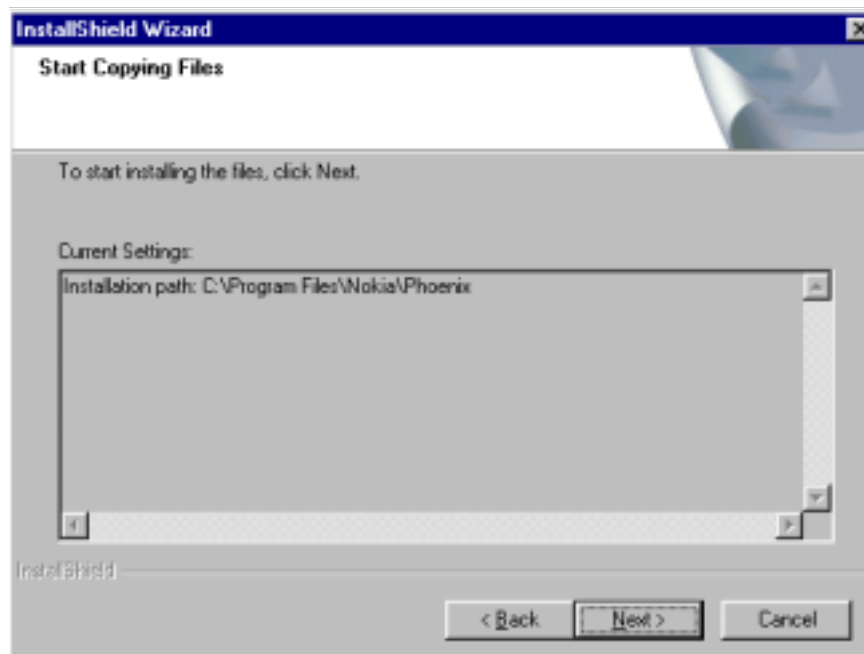

Phone model specific files will be installed... please wait.

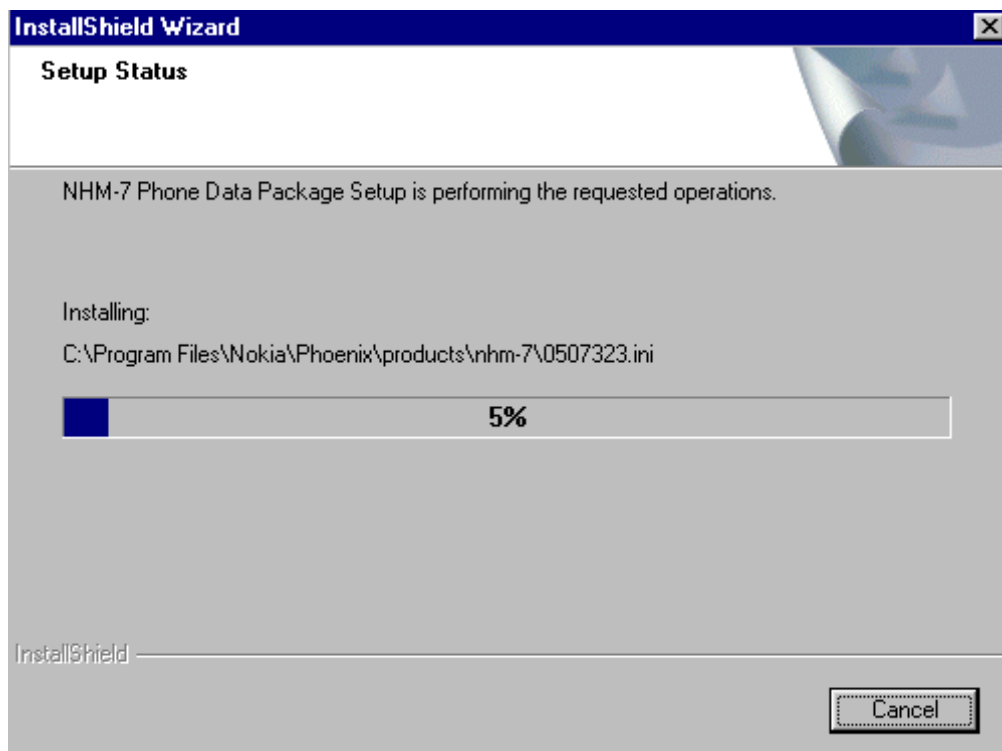

Choose "Finish" to complete installation.

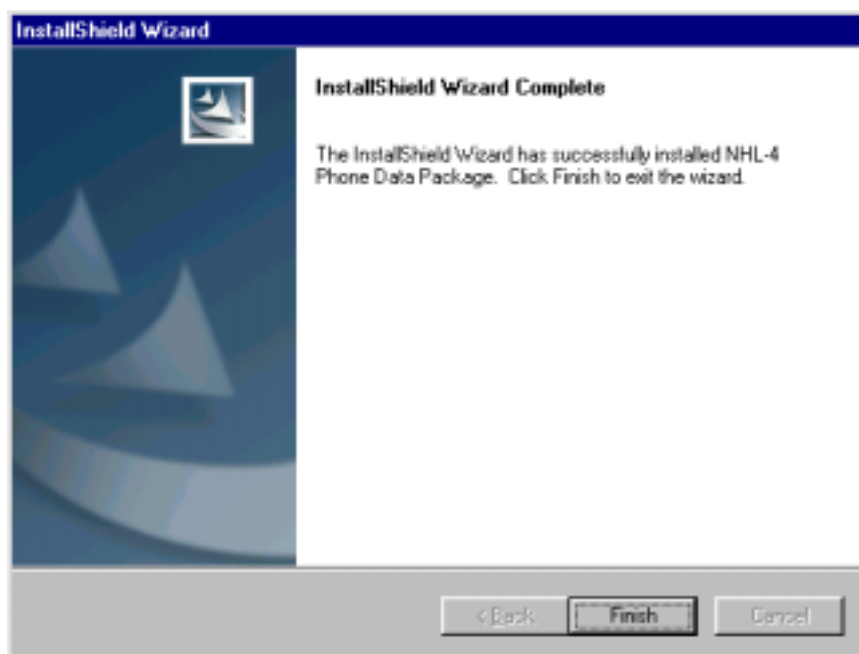

You now have all phone model specific files installed in your Phoenix Service SW.

## How to Uninstall Data Package

Uninstallation can also be done manually from Windows Control Panel / Add / Remove Programs/ "NHL-4 Phone Data Package".

If you try to install the same version of Phoenix Data Package that you already have, you are asked if you want to uninstall the version you have on your PC. Answer "OK" to uninstall, "Cancel" if you don't want to uninstall. Older versions of data packages do not need to be uninstalled.

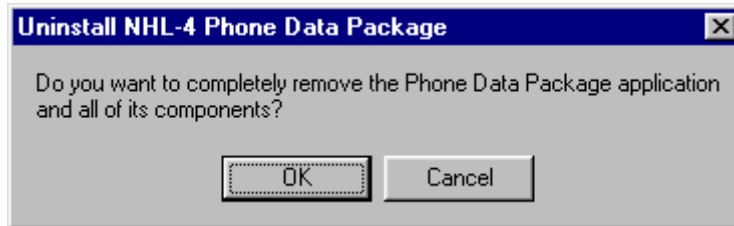

Once the previously installed Data package is uninstalled, choose "Finish".

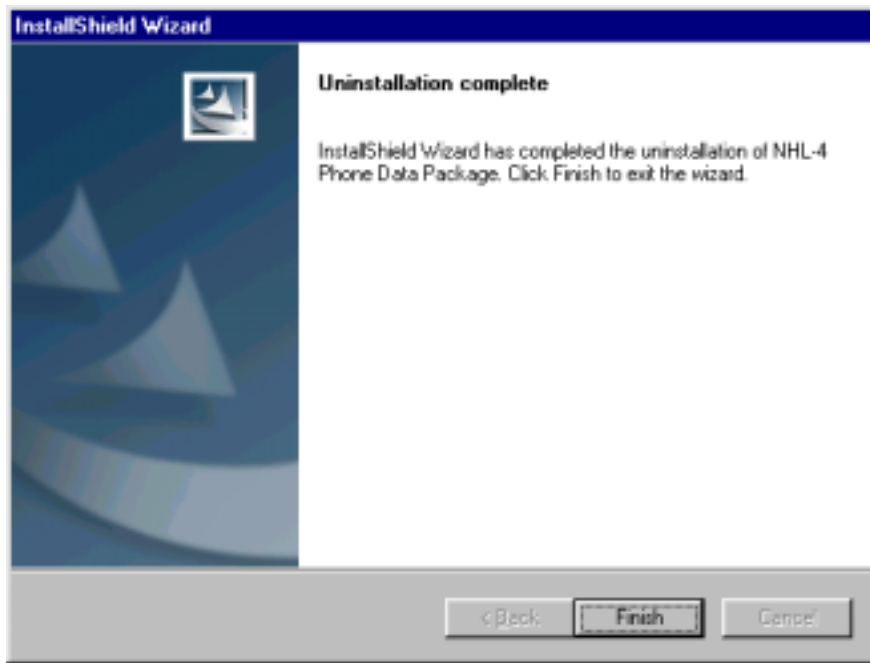

Run the *nhl-4\_dp\_v\_1.00.exe* again to continue installation from the beginning.

## How to Manage Connections

Start Phoenix Service SW and Login.



Choose "Manage Connections" From "File" – Menu

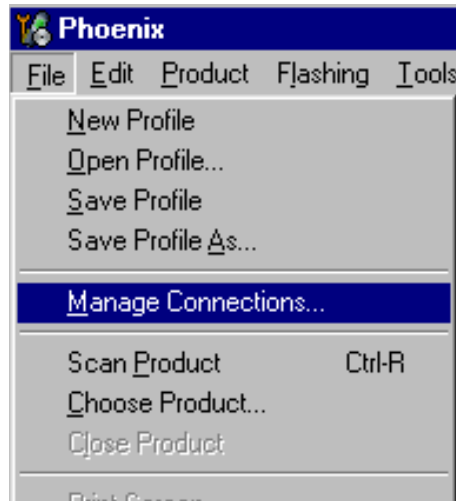

Existing connections can be selected, edited, deleted and new ones created by using this dialog.

A connection can be created either manually or by using a Connection Wizard.

To add new connection, choose "Add" and select if you want to create it manually or by using the Wizard.

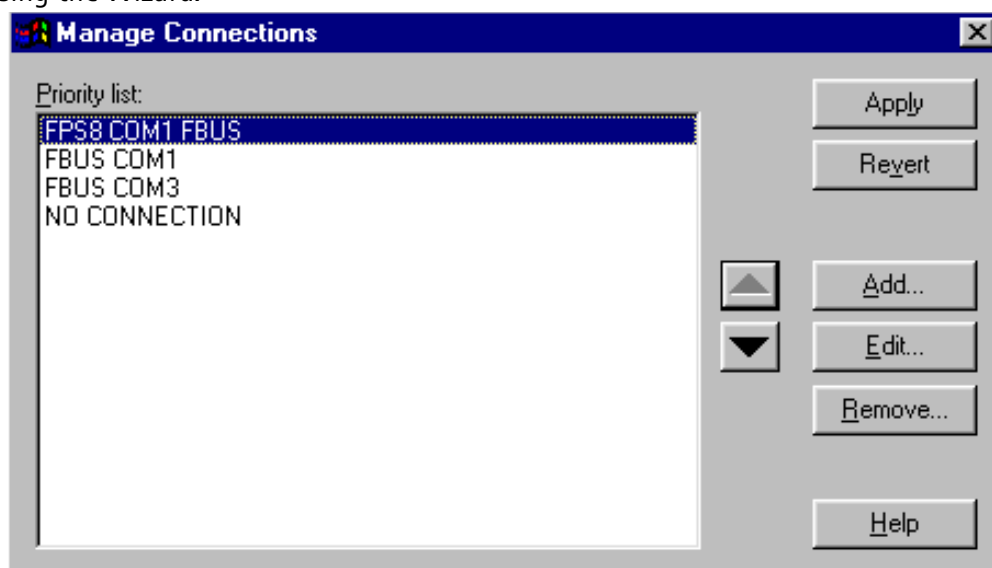

Choose "Next" to continue.

In the next dialogs you will be asked to select some settings for the connection

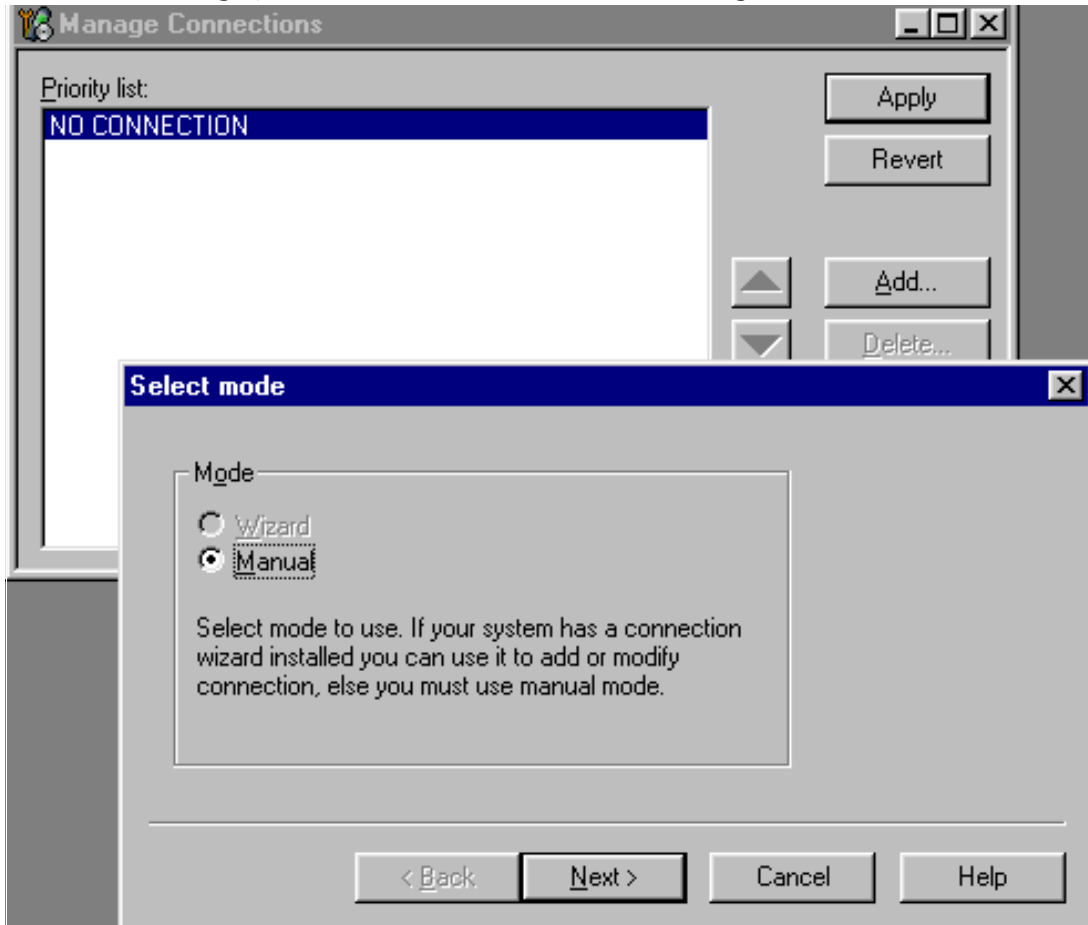

**Manual Settings**

A) For FLS-4S POS Flash Device choose following connection settings

**Media:** FBUS

**COM Port:** Virtual COM Port used by FLS-4 Please check this always!

(To check please go to Windows / Control Panel / FLS Virtual Port / Configuration)

B) For FPS-8 Flash Prommer choose following connection settings:

**Media:** FPS-8

**Port Num:** COM Port where FPS-8 is connected

**COMBOX\_DEF\_MEDIA:** FBUS

Choose "Finish" to complete.

If you use the Wizard, connect the tools and a phone to your PC and the wizard will automatically try to configure the correct connection.

Activate the connection you want to use by clicking it and use up/down arrows to move it on top of the list. Choose "Apply".

The connection is now selected and can be used after closing the "Manage Connections" window.

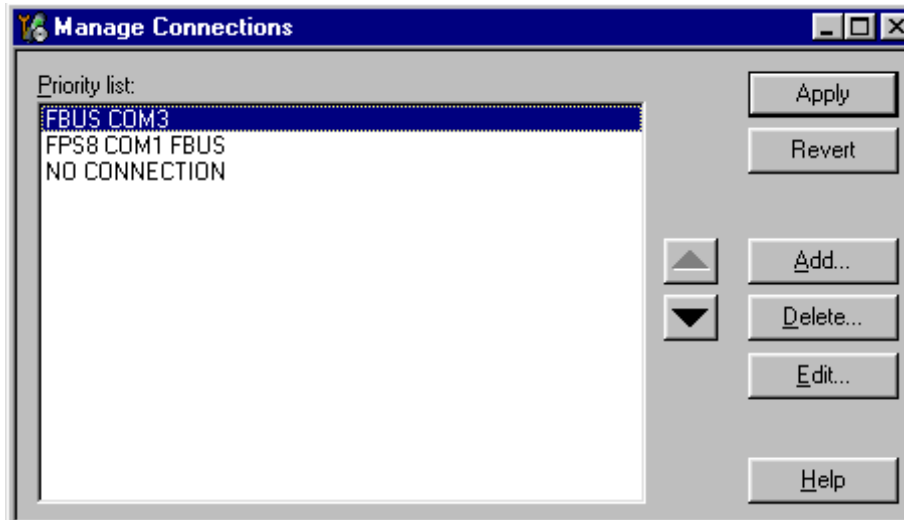

Selected connection will be shown on the right hand bottom corner of the screen.



To use the selected connection, connect the phone to Phoenix with correct service tools, make sure that it is switched on and select "Scan Product".

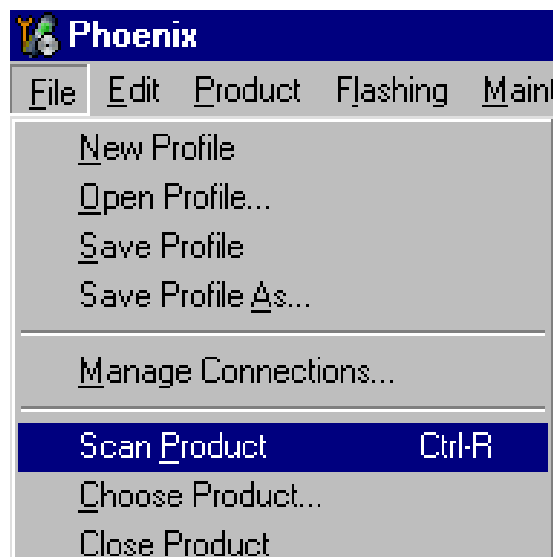

When the Product is found, Phoenix will load product support and when everything is ready, name of the loaded product support module and its version will be shown on the bottom of the screen.

V 3.08 , 24-09-02 , NHL-4 , (c) NMP.

## How to Update Flash Support Files for FPS-8\* and FLS-4\*

### Before Installation

- Install Phoenix Service SW and Phoenix data package.
- Install the phone model Specific Datapackage for Phoenix
- The flash support files are delivered in the same installation package with Phoenix data package.
- Normally it is enough to install the data package only before updating the FPS-8.
- Separate installation package is for flash support files are available, and the files can be updated according to this instruction.

### Installing the Flash Support Files

Start by double clicking eg. *flash\_update\_02\_10\_00.exe*. Installation begins.

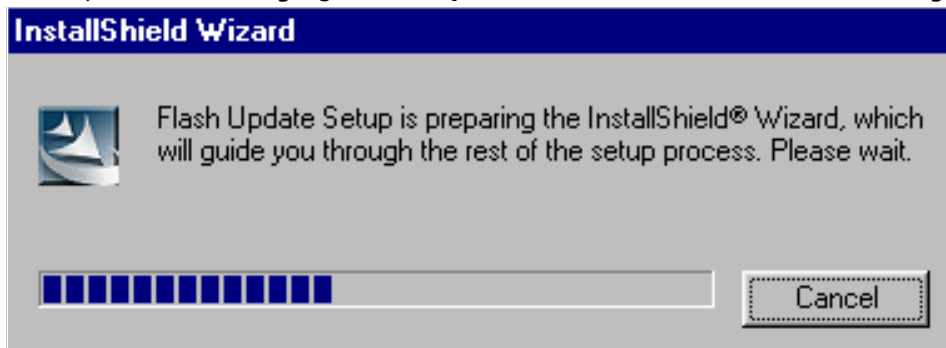

If you already have the same Flash Update package files installed, you need to confirm if you want them to be reinstalled.

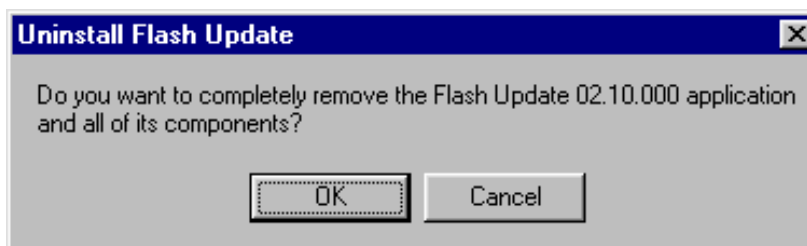

Choose "Next" to continue installation

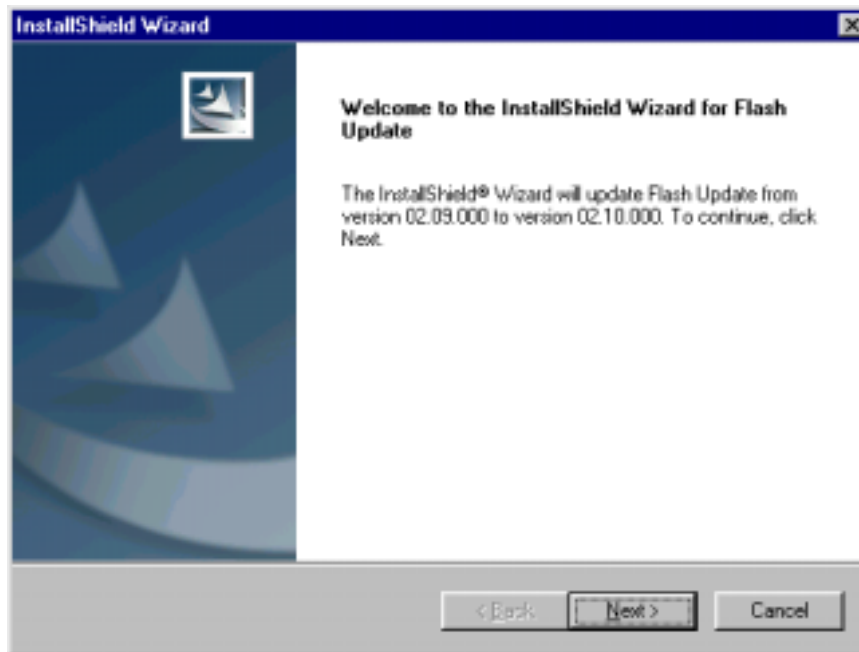

It is **highly** recommended to install the files to the default destination folder *C:\Program Files\Nokia\Phoenix*.

Choose "Next" to continue. You may choose another location by selecting "Browse" (not recommended).

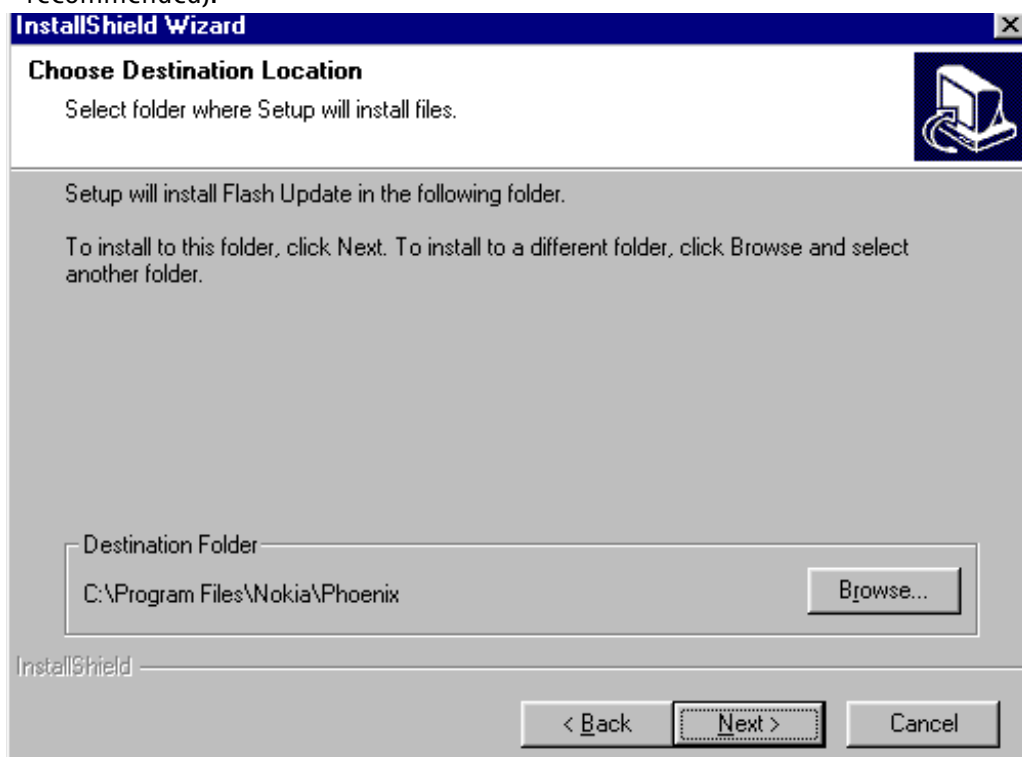



Installation continues...

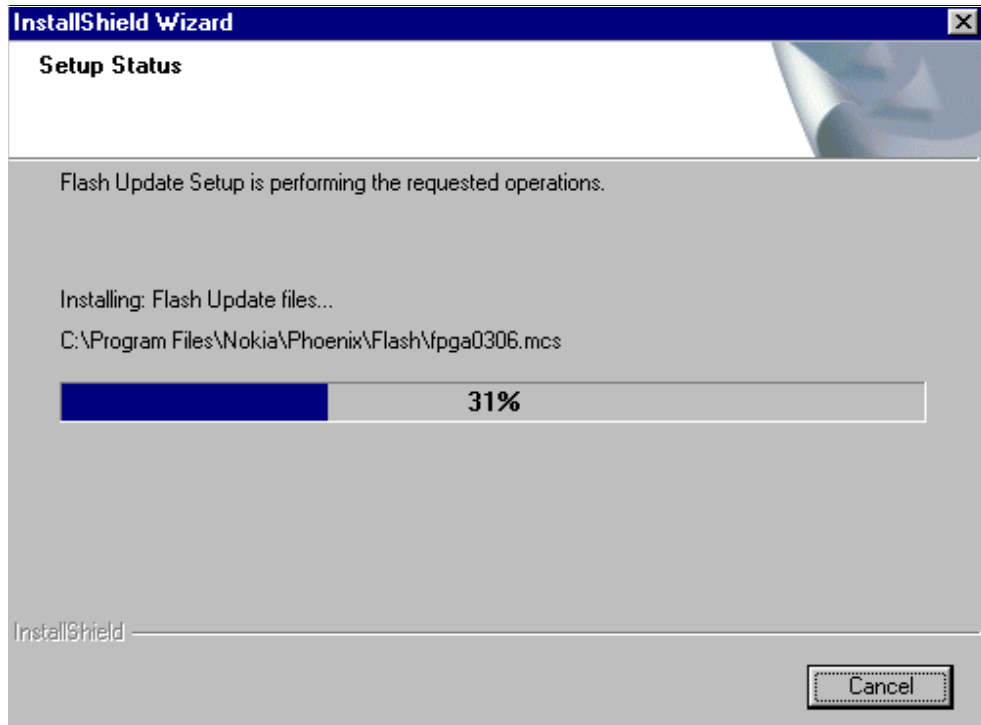

Choose "Finish" to complete procedure.

- **FLS-4 can be used right after Flash Update Package is installed.**
- **FPS-8\* must be updated by using Phoenix!**

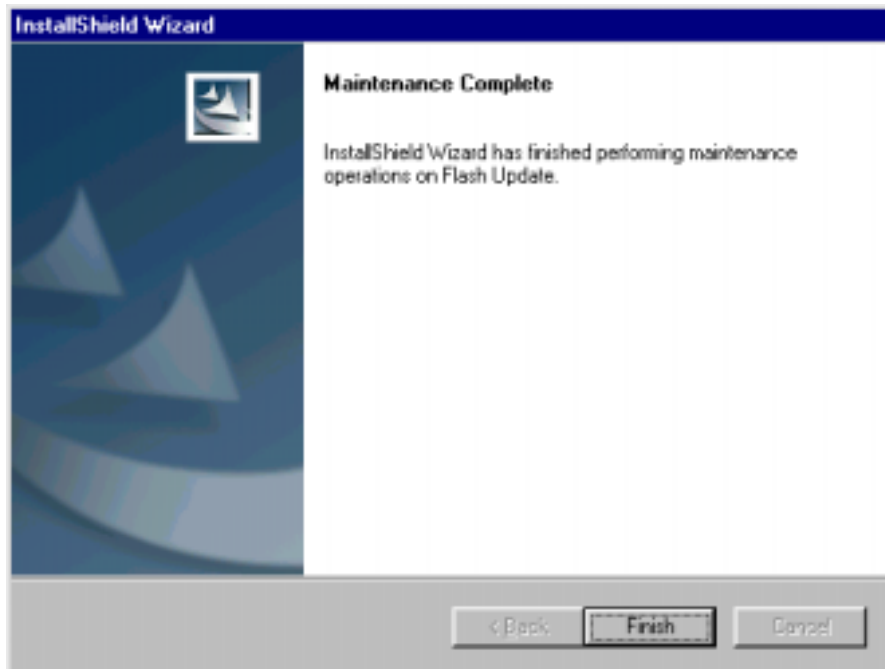

## How to Update The FPS-8\* Flash Prommer SW

Start Phoenix Service Software



Select "FPS-8 / FPS-8C maintenance" from "Flashing" menu.

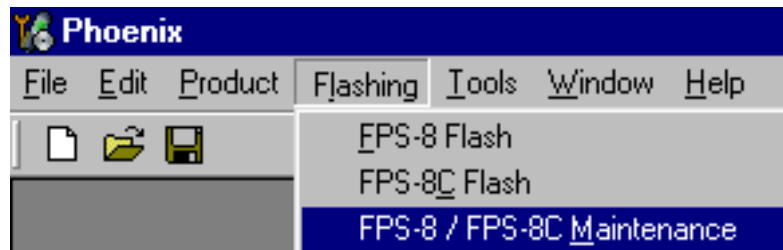

When new FPS-8 flash update package is installed to computer you will be asked to update the files to your FPS-8 Prommer. Select "Yes" to update files..



Update procedure takes a couple of minutes.

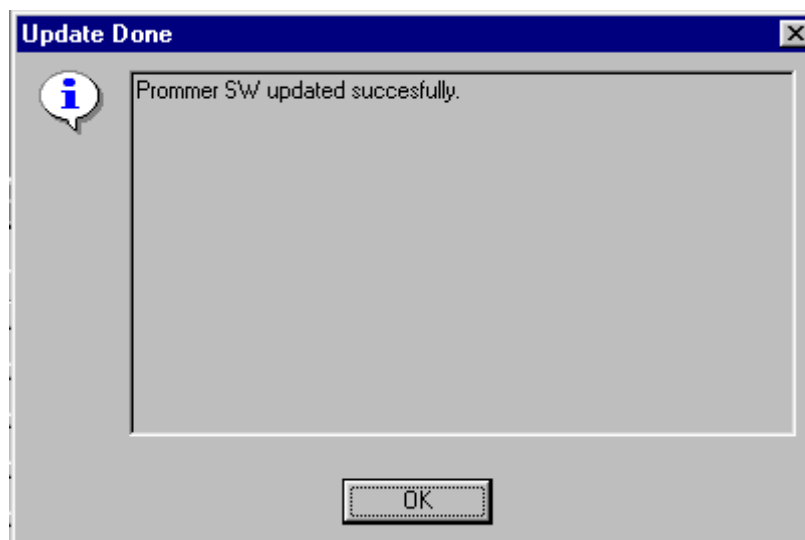

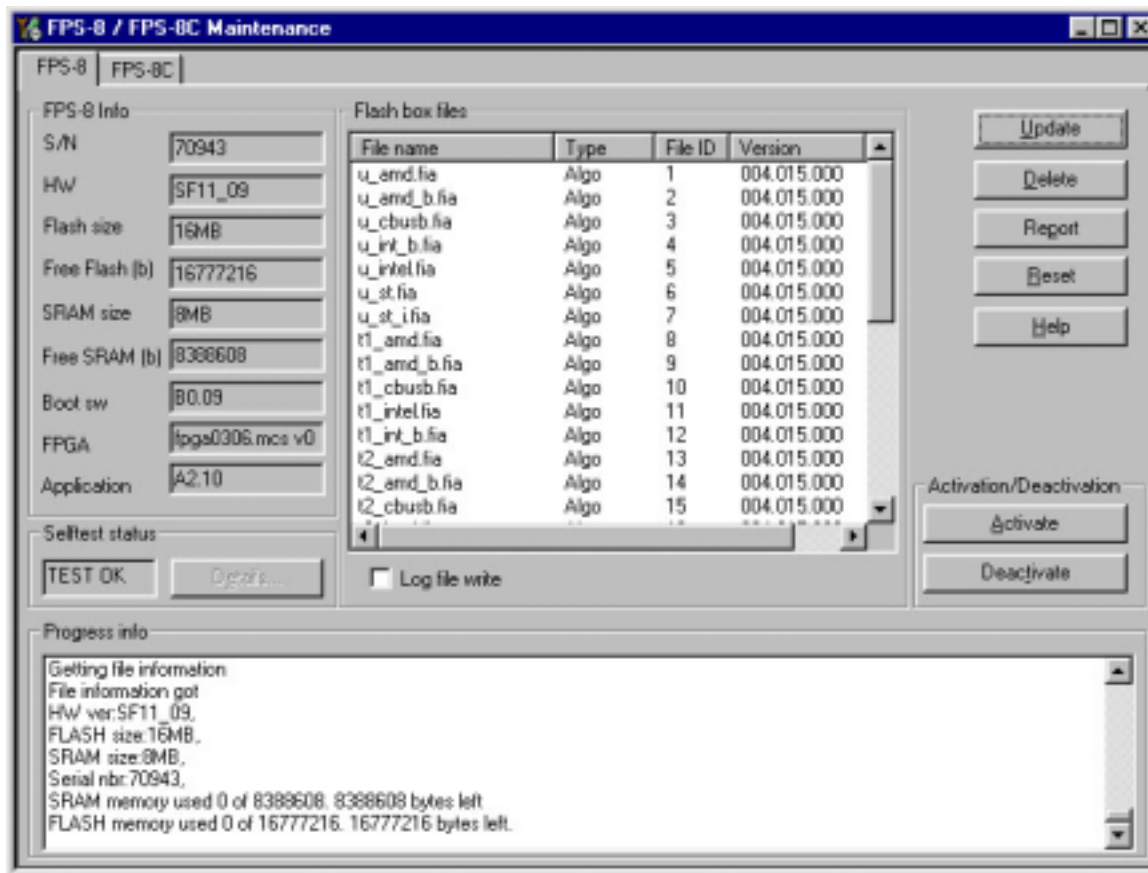

FPS-8 sw can also be updated by pressing "Update" button and selecting appropriate **fps8upd.ini** file under **C:\Program Files\Nokia\Phoenix\Flash** - directory

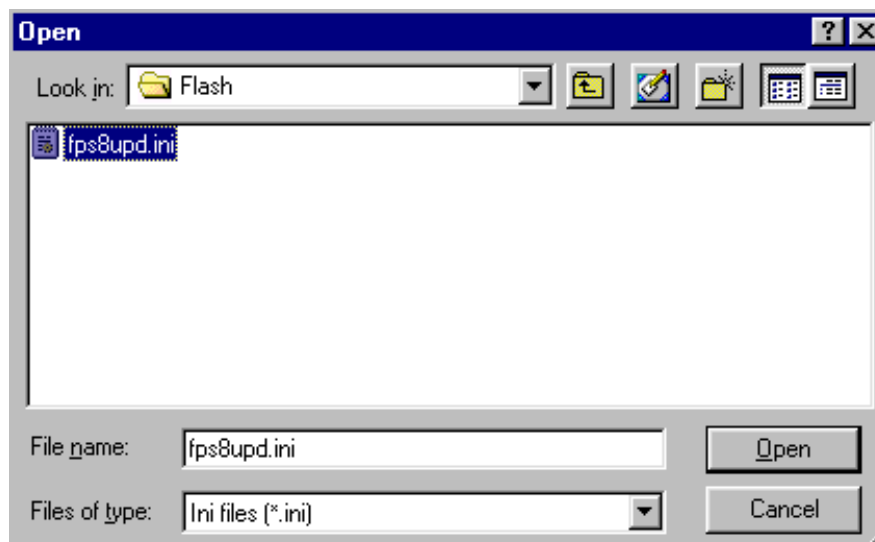

All files can be loaded separately to FPS-8. To do this, just press right mouse button in "Flash box files" window and select file type to be loaded.

More information and help can be found from the "Help" dialog.

## FPS-8 Activation and Deactivation

- Before the FPS-8 can be successfully used for phone programming, it must be first activated.
- If there is a need to send FPS-8 box to somewhere e.g. for repair, box must be first deactivated.

### Activation

Before FPS-8 can be successfully used for phone programming, it must be first activated.

Fill in first "FPS-8 activation request" sheet, in the FPS-8 sales package and follow the instructions in the sheet.

When activation file is received (e.g. 00000.in), copy it to **C:\Program-Files\Nokia\Phoenix\BoxActivation** - Directory on your computer (This directory is created when Phoenix is installed).

Start Phoenix Service Software.

Select "FPS-8 / FPS-8C maintenance" from "Flashing" menu.

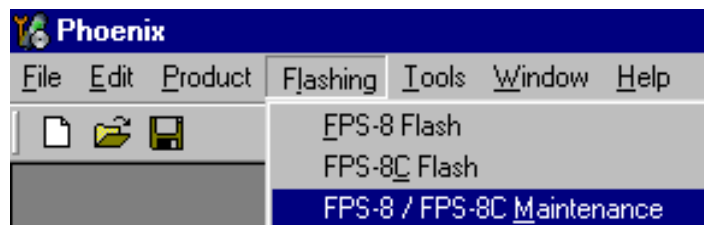

Select "Activate" from the "FPS8/8C Maintenance" – UI.

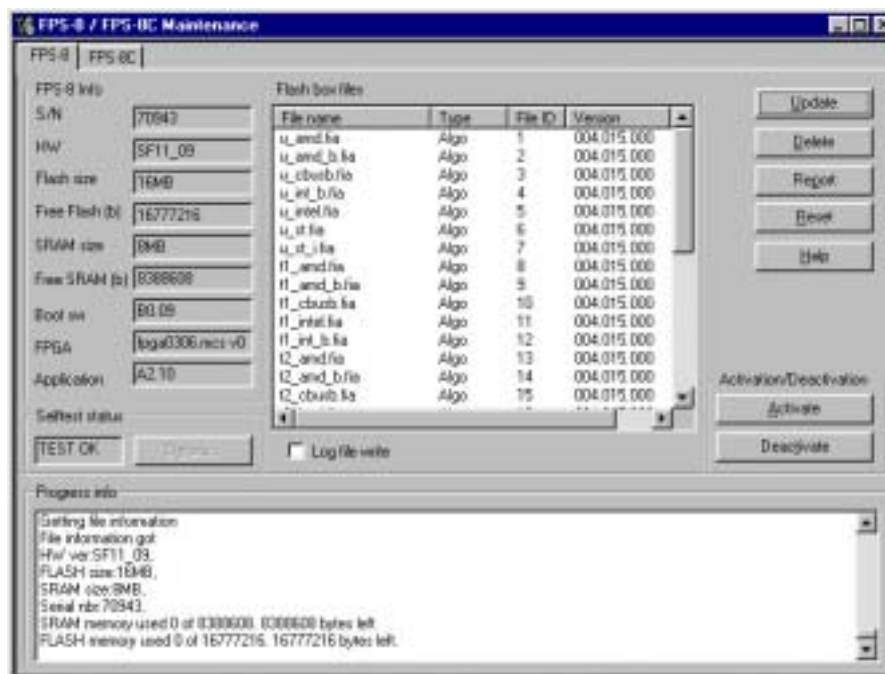

The activation file you saved to *C:\ProgramFiles\Nokia\Phoenix\BoxActivation* - directory will be shown (e.g. 00000.in), check that it is correct.

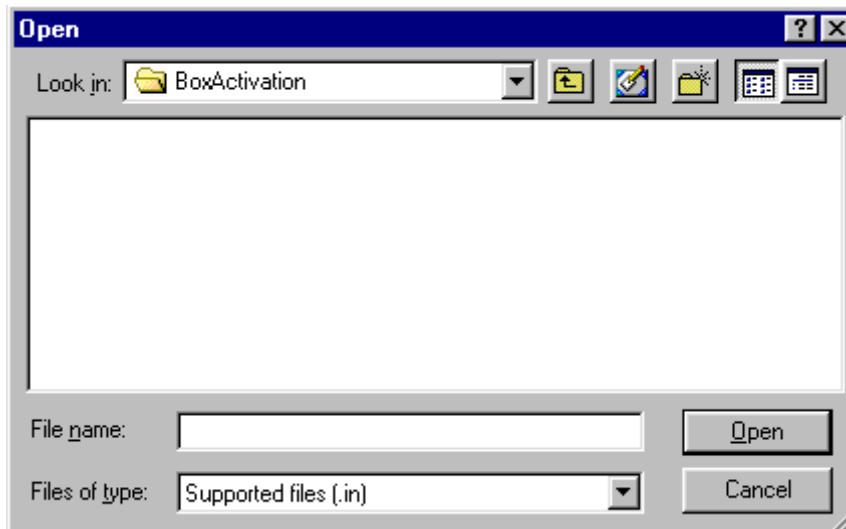

Box will be activated when you choose "Open"

Turn FPS-8 power off and on to complete activation

## Deactivation

Start Phoenix Service Software.

Select "FPS-8 / FPS-8C maintenance" from "Flashing" menu

Select "Deactivate" from the "FPS8/8C Maintenance" – UI.

Confirm Deactivation by choosing "Yes", Box will be deactivated.

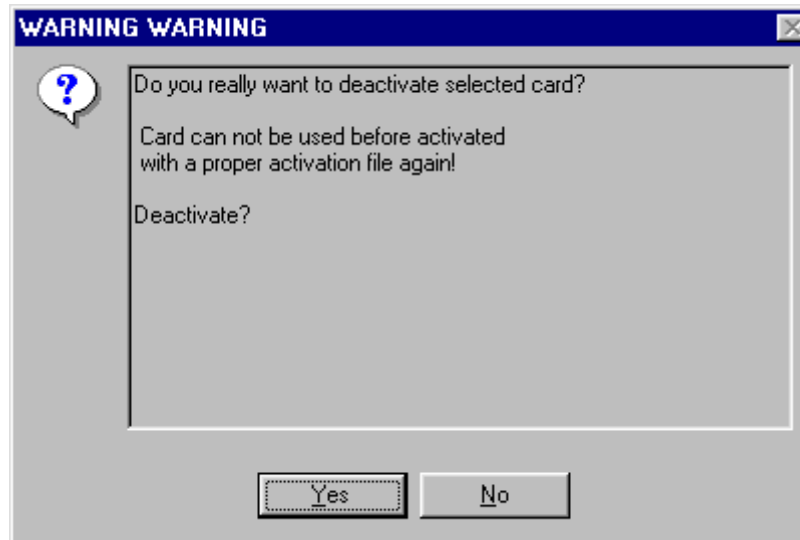

Turn FPS-8 power off and on to complete deactivation

## JBV-1 Docking Station SW

The JBV-1 Docking Station is a common tool for all DCT-4 generation products. In order to make the JBV-1 usable with different phone models, a phone specific Docking Station Adapter is used for different service functions.

The JBV-1 Docking Station contains Software (Firmware) which can be updated.

You need the following equipment to be able to update JBV-1 software:

- PC with USB connection
- Operating System supporting USB (Not Win 95 or NT)
- USB Cable (Can be purchased from shops or suppliers providing PC hardware and accessories)
- JBV-1 Docking Station
- External Power Supply 11-16V

### Before Installation

- Download *Jbv1\_update.zip* – file to your computer (e.g. C:\TEMP) from your download web site.
- Close all other programs
- Follow instructions on the screen

## Installing SW Needed for the JBV-1 SW Update

*Note: DO NOT CONNECT THE USB CABLE / JBV-1 TO YOUR COMPUTER YET!*

Run *Jbv1\_update.zip* file and start SW Installation by double clicking *Setup.exe*.

Files needed for JBV-1 Package setup Program will be extracted.

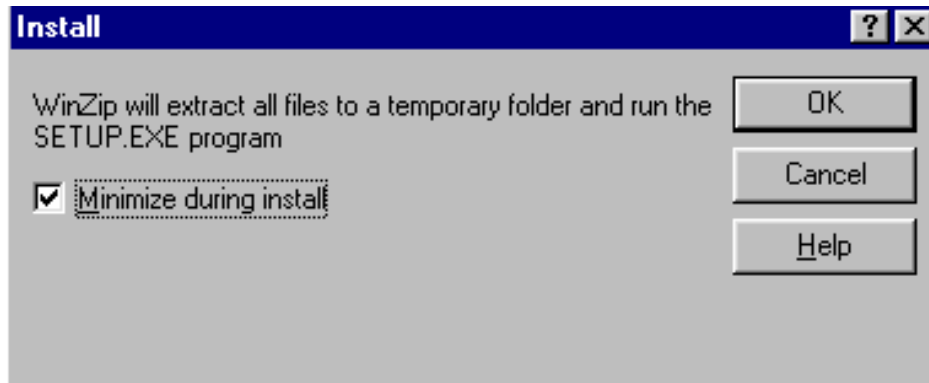

Installation begins, please read the information shown and Choose "Next" to continue.

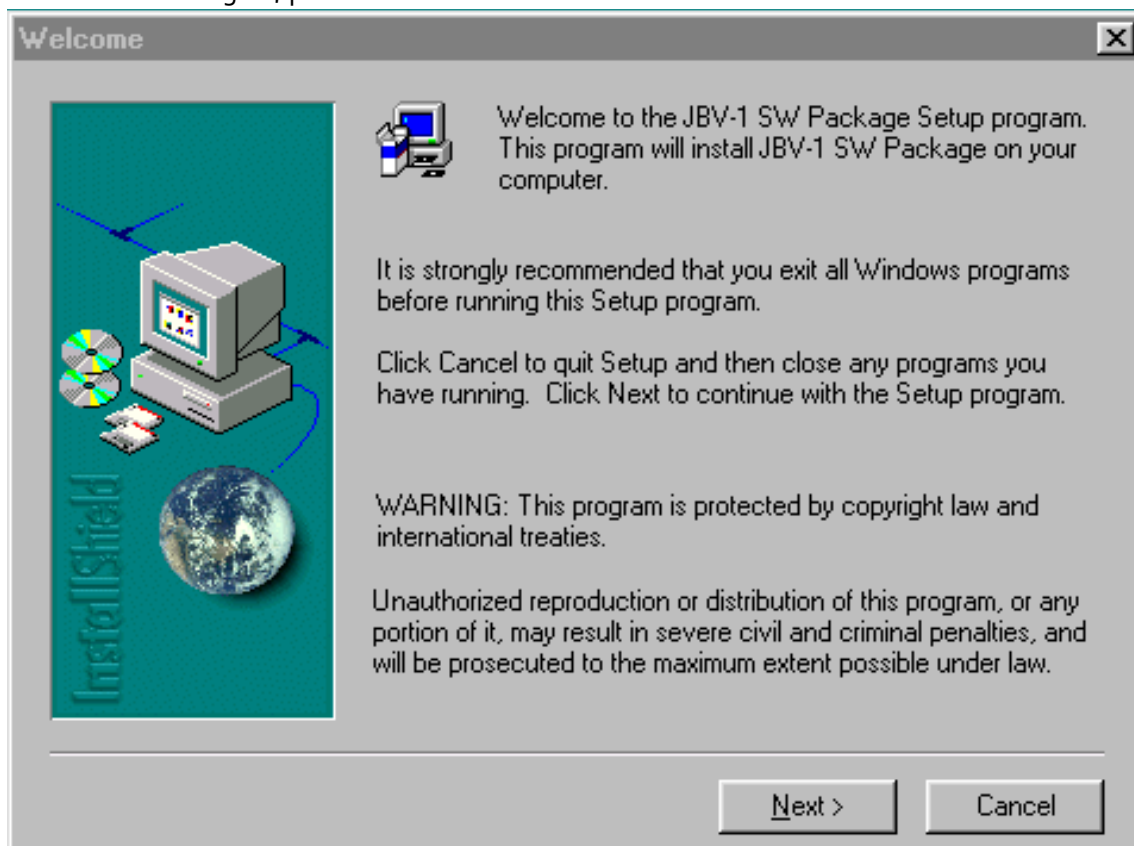

Use suggested destination folder where JBV-1 SW Package will be installed and choose



"Next" to continue.

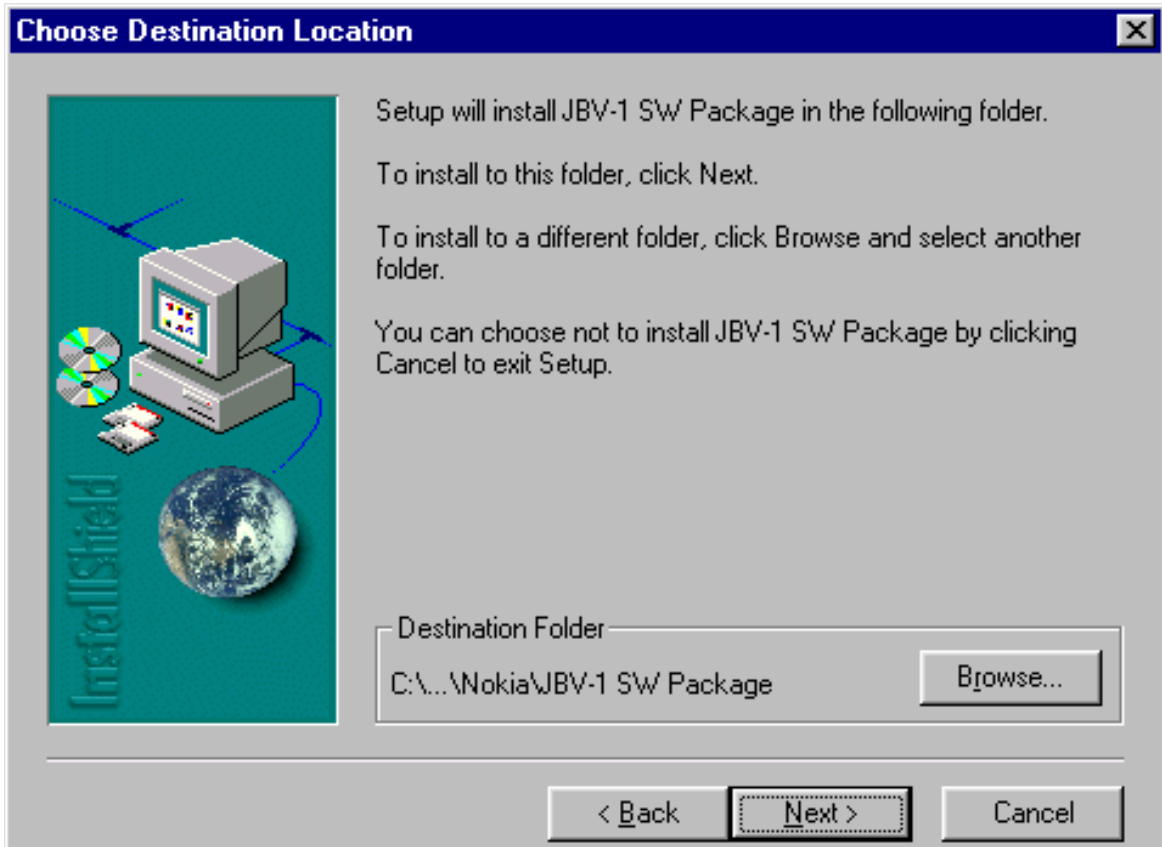

Select "Full" Installation and choose "Next" to continue



Program Folder will be created. Choose "Next" to continue, Software files will be

installed.

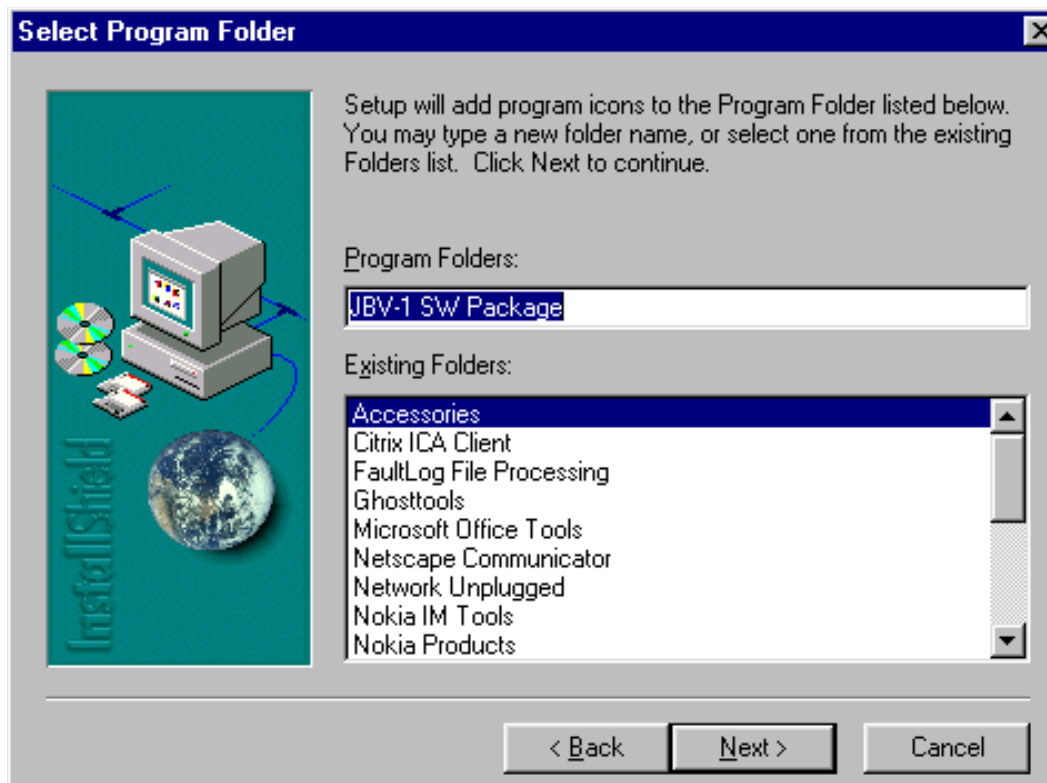

After successful installation, choose "Finish" to complete.



**NOW YOU CAN CONNECT THE USB CABLE / JBV-1 TO YOUR COMPUTER!**

Connect power to JBV-1 (11-16V DC) from external power supply, then connect USB Cable between JBV-1 USB connector and PC.

Windows will detect connected USB cable and detect drivers for new HW.

Follow the instructions and allow Windows to search and install the best drivers available. After this procedure the actual JBV-1 SW update can begin.



## Updating the JBV-1 Docking Station Software

Go to folder *C:\Program Files\Nokia\JBV-1 SW Package\FIRMWARE UPDATE* and start JBV-1 Update SW by double clicking *fwup.exe*.

JBV-1 Firmware update starts and shows current status of the JBV-1 connected.

If firmware version read from your JBV-1 is not the latest one available, it needs to be updated by choosing "Update Firmware".

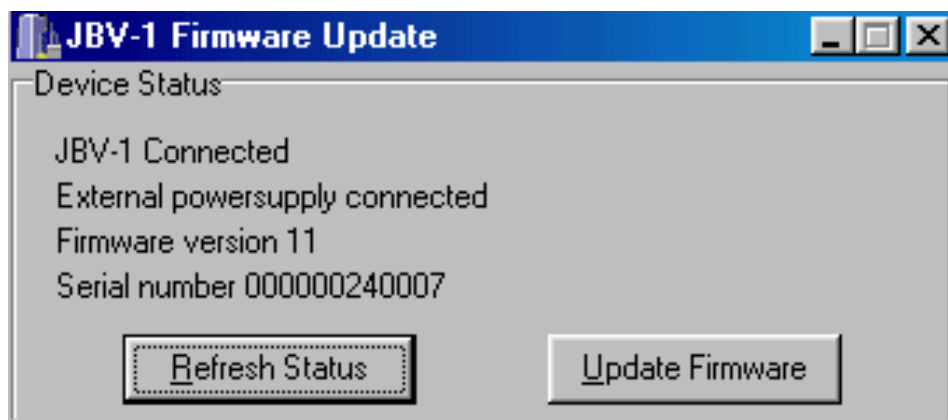

Choose file *JBV1v11.CDE* (example used here is for v 11) and "Open" to update your JBV-1.

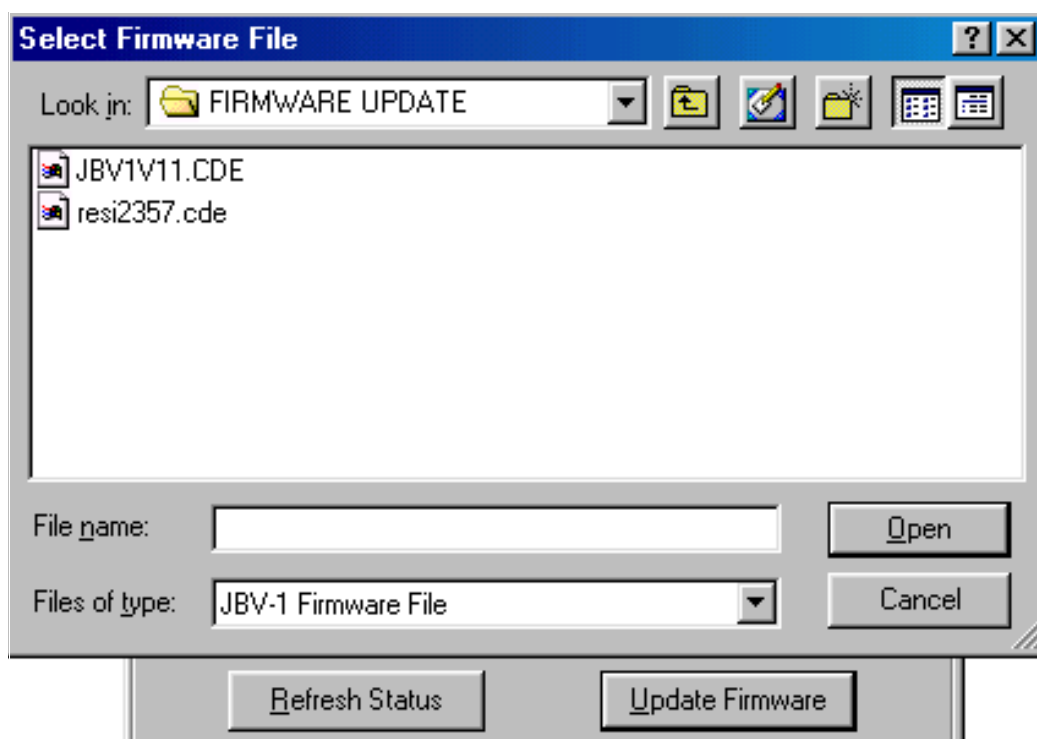

After Successful update, current JBV-1 status will be shown. You have now updated the

software of your JBV-1 docking station and it is ready for use.

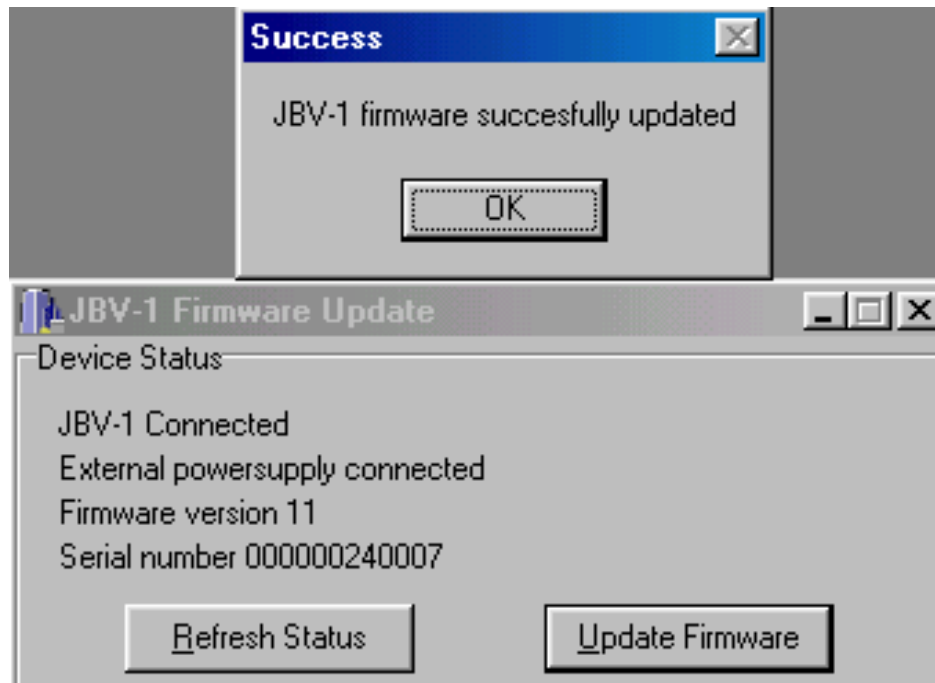

[This page left intentionally blank]

## Receiver tuning: Quick Guide for Tuning With Phoenix



### General remarks

RF tunings must be performed in the same order as shown in this document. The order of the corresponding menu items in the Phoenix Service SW may be different.

If baseband tunings are needed, they should be completed before the RF tunings

Avoid unnecessary tuning – factory-tuning values are always the most accurate ones.

Screen shots described in this document may change as the service software is developed.

Kindly refer to the Phoenix help files, the phone model specific service manual and bulletins for help.

## Service Tool Concept for RF Tuning Operations

- All RF tuning operations must be carried out in the MJS-38 Module Jig!
- **JBV-1 Docking station with MJF-13 Docking Station Adapter must not be used for RF tunings, only for testing!**
- Power to MJS-38 must be supplied from an external DC power supply, not FPS-8 prommer
- MJS-38 input voltages:
  - Maximum + 5 VDC
  - Nominal input for RF tunings is +4.2 V DC
  - Minimum +3V DC
- Remember the cable attenuation when setting required RF levels

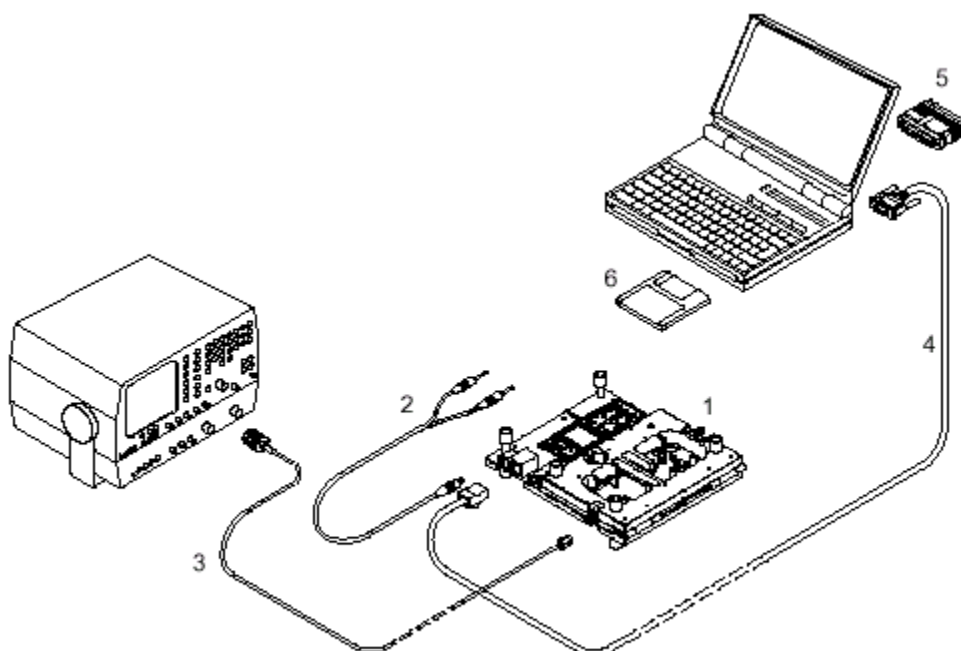

Figure 1: RF tuning setup

Item:	Service accessory:	Type:	Product code:
1	Module jig	MJS-38	0770416
2	DC power cable	PCS-1	0730012
3	Modular cable	XRF-1	0730085
4	Service Mbus cable	DAU-9S	0730108



Item:	Service accessory:	Type:	Product code:
5	Software protection key	PKD-1,	0750018
10	Phoenix Service SW		8409031
11	Phoenix Service SW	CD-ROM	0774286

## Receiver Tuning: RX Channel Select Filter Calibration

Extra equipment / external RF signal not needed.

Must be done before other RX calibrations.

This function is used to calibrate RX channel select filter in GSM Phones.

Rx Channel select filter is tuned only in one band = Single calibration for both bands.

Select Maintenance => Tuning => Rx Channel select filter calibration.

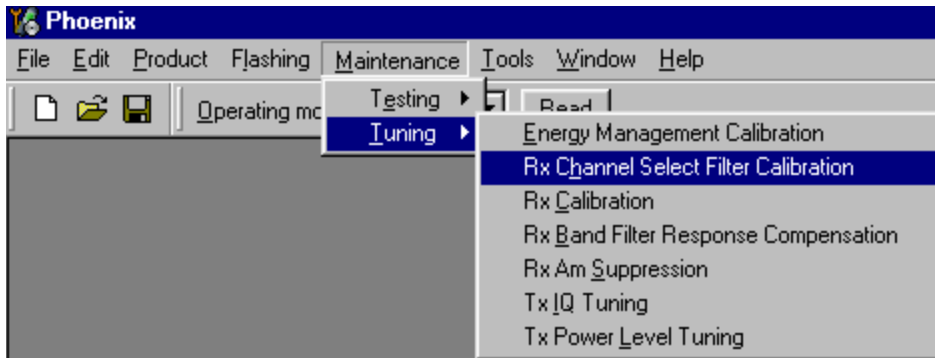

"Save to Phone " is checked by default

*Uncheck "Save to Phone " if you don't want the values to be saved to phone (eg testing)!*

Press "Tune" to start the tuning



### Tuning values must be 0...31

If values shown are within limits, choose "Stop"

IClose the "RX Channel Select Filter Calibration "– dialog to end tuning

Close the Rx Channel select filter calibration – dialog, the values are saved to phone

## RX Calibration

RF generator needed.

This tuning performs RX Calibration.

Must be done separately on every band!

Calibration is automatically performed at EGSM (GSM900), then at GSM1800 and finally at GSM1900 band. If tuning is successful, tuning continues in the next band.

AFC tuning is done while EGSM (GSM900) band RX Calibration is performed.

Remember to take jig and cable attenuations into account!

Select Maintenance => Tuning => Rx calibration

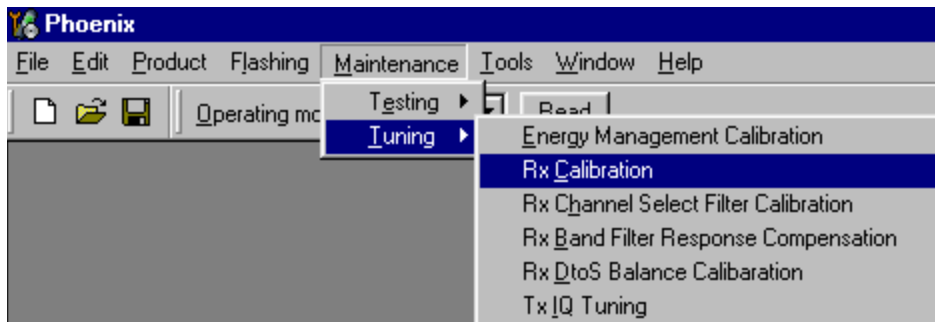

Press "Calibrate" to start tuning.

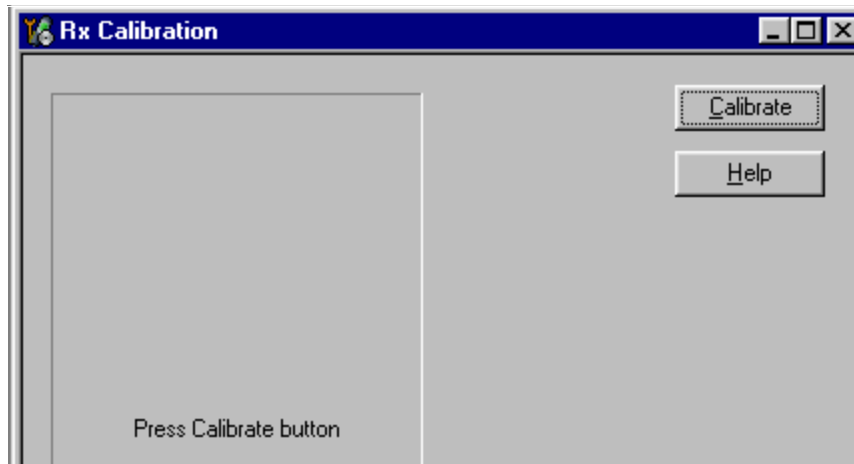

Set RF generator to required EGSM900 frequency => OK

Set RF generator to required frequency => OK

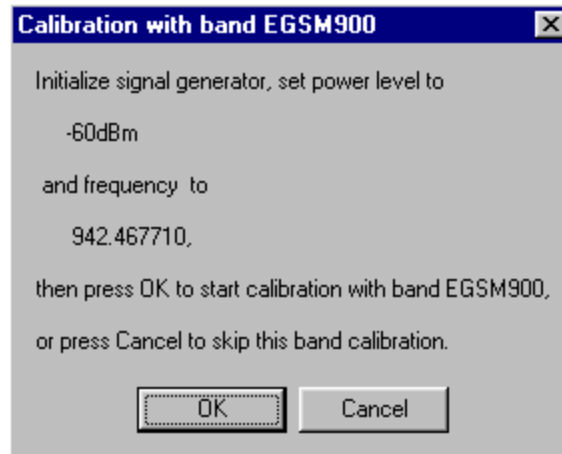

Tuning values and ADC readings are shown.

#### Typical values and limits in (GSM900) RX Calibration:

EGSM (GSM900)	Typical value	Low limit	High limit
Afc value:	-90	-350	350
Afc slope:	270	150	350
Rssi 0:	65.09375	58	68
Rssi 1:	71.09375	64	74
Rssi 2:	76.90625	70	80
Rssi 3:	82.90625	76	86
Rssi 4:	88.90625	82	92
Rssi 5:	93.71875	88	98
Rssi 6:	99.71875	94	104
Rssi 7:	105.53125	100	110
Rssi 8:	111.53125	106	116
Rssi 9:	117.53125	112	122
Rssi 10:	123.53125	118	128
Rssi 11:	129.53125	124	134
Rssi 12:	135.53125	130	140
Rssi 13:	141.53125	136	146
Rssi 14:	147.53125	142	152

Set RFgenerator to required GSM1800 frequency => OK



Tuning values and ADC readings are shown.

**Typical values and limits in (GSM1800) RX Calibration**

GSM1800	Typical value	Low limit	High limit
Rssi 0:	62.40625	58	68
Rssi 1:	68.40625	64	74
Rssi 2:	74.265625	70	80
Rssi 3:	80.265625	76	86
Rssi 4:	86.265625	82	92
Rssi 5:	91.859375	88	98
Rssi 6:	97.859375	94	104
Rssi 7:	103.71875	100	110
Rssi 8:	109.71875	106	116
Rssi 9:	115.71875	112	122
Rssi 10:	121.71875	118	128
Rssi 11:	127.71875	124	134
Rssi 12:	133.71875	130	140
Rssi 13:	139.71875	136	146
Rssi 14:	145.71875	142	152

Set the RF generator to required GSM1900 frequency => OK



Tuning values and ADC readings are shown.

#### Typical values and limits in (GSM1900) RX Calibration

GSM1900	Typical value	Low limit	High limit
Rssi 0:	66.25	61	71
Rssi 1:	72.25	67	77
Rssi 2:	78.09375	73	83
Rssi 3:	84.09375	79	89
Rssi 4:	90.09375	85	95
Rssi 5:	93.25	88	98
Rssi 6:	99.25	94	104
Rssi 7:	105.09375	100	110
Rssi 8:	111.09375	106	116
Rssi 9:	117.09375	112	122
Rssi 10:	123.09375	118	128
Rssi 11:	129.09375	124	134
Rssi 12:	135.09375	130	140
Rssi 13:	141.09375	136	146
Rssi 14:	147.09375	142	152

If values are within limits, they are saved to the phone after successful tuning of each band.

Close the "Rx Calibration" dialog to end tuning

## RX Band Filter Response Compensation

RF generator needed.

This operation must be done separately on each band!

Start RX Calibration at EGSM (GSM900), then continue at GSM1800 band and finally on the GSM1900 band

*NOTE! Remember to do RX calibration before doing Rx Band Filter Response Compensation!*

Remember to take jig and cable attenuations into account!

Select Maintenance => Tuning => Rx band filter response compensation

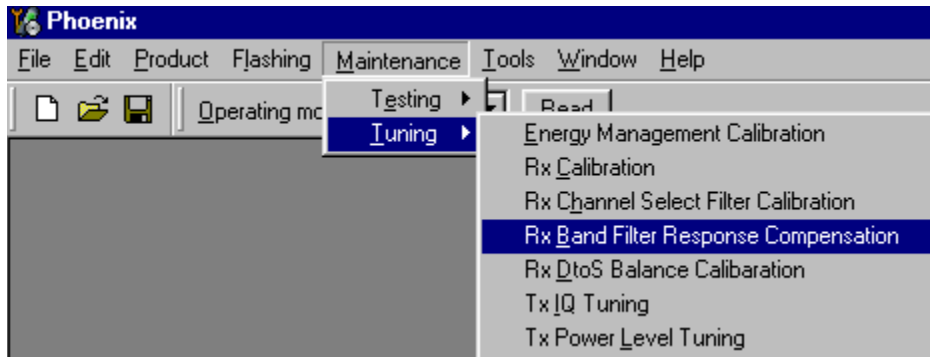

Select "Yes" to start tuning with values already saved to the phone

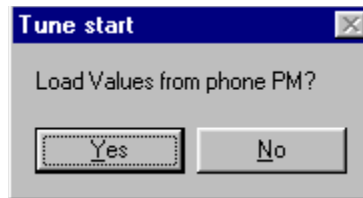

Set RF to 923.26771MHz level -80dBm.

Select "Manual tuning" and tuning starts.

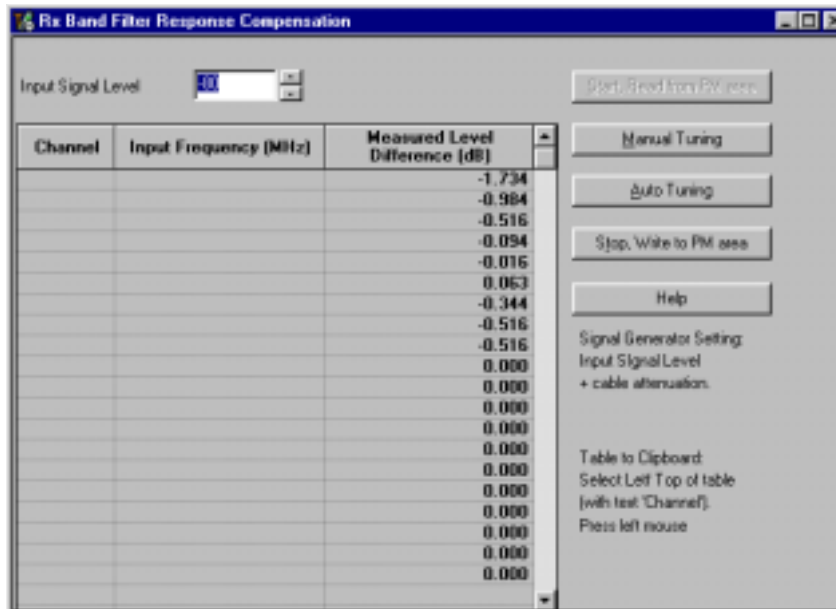

You are asked to supply 9 different RF frequencies to the phone.

The tuning begins from EGSM900 band and continues the same way for GSM 1800 and GSM1900 bands

Set the first required frequency and level => OK

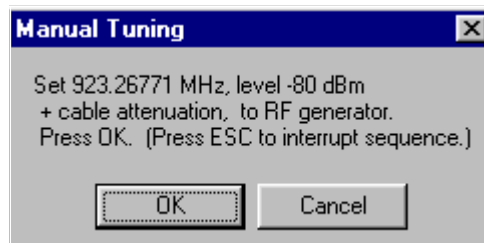

Set the 2nd required frequency and level => OK

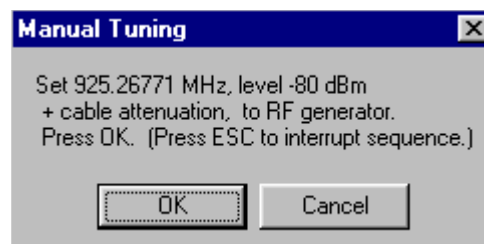



Set the 3rd required frequency and level => OK

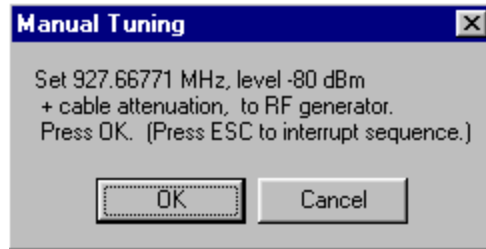

Set the 4th required frequency and level => OK

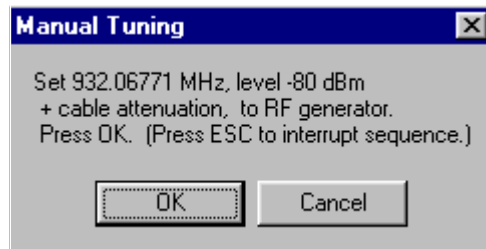

Set the 5th required frequency and level => OK

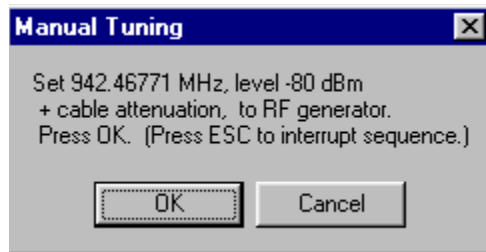

Set the 6th required frequency and level => OK

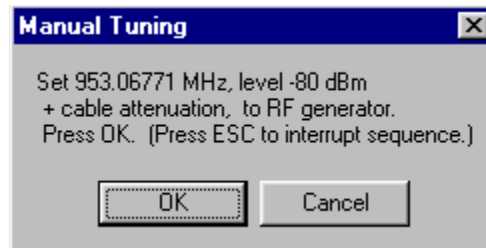

Set the 7th required frequency and level => OK

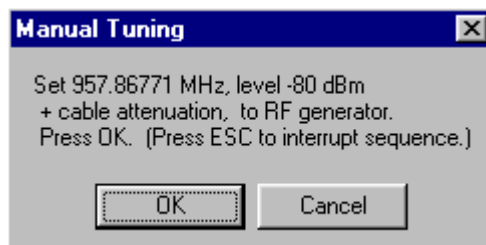

Set the the 8th required frequency and level => OK

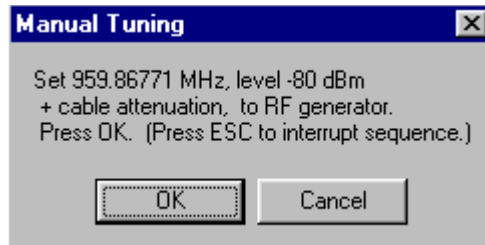

Set 9th required frequency and level => OK

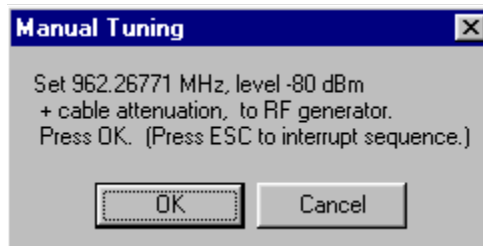

Typical values and limits in Rx Band Filter Response Compensation EGSM900:

Channel	Input frequency (MHz)	Typ.	Low limit (dB)	High limit (dB)
965	923.26771	-1.266	-10	3.5
975	925.26771	-0.641	-3.5	3.5
987	927.66771	-0.188	-3.5	3.5
1009	932.06771	-0.094	-3.5	3.5
37	942.46771	-0.188	-3.5	3.5
90	953.06771	-0.391	-3.5	3.5
114	957.86771	-0.266	-3.5	3.5
124	959.86771	-0.359	-3.5	3.5
136	962.26771	-0.453	-10	3.5

Choose "Stop, write to PM area"

If the values shown are within limits, choose "Yes" to save values to the phone.

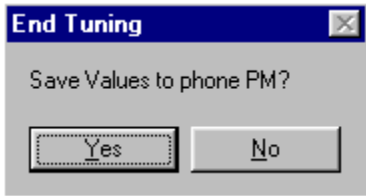

Continue tuning from GSM1800. Choose the correct band from the dropdown menu.

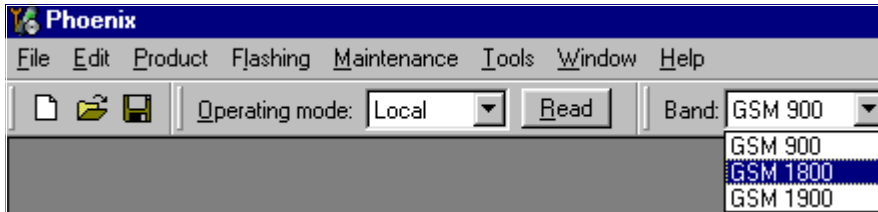

Repeat the same steps as for the EGSM900 band above.

Typical values and limits in Rx Band Filter Response Compensation GSM1800:

Channel	Input frequency (MHz)	Typ.	Low limit (dB)	High limit (dB)
497	1802.26771	-1.578	-10	3.5
512	1805.26771	-1.281	-3.5	3.5
535	1809.86771	-1.188	-3.5	3.5
606	1824.06771	-0.422	-3.5	3.5
700	1842.86771	-0.125	-3.5	3.5
791	1861.06771	0.016	-3.5	3.5
870	1876.86771	0.094	-3.5	3.5
885	1879.86771	0.016	-3.5	3.5
908	1884.46771	-0.047	-10	3.5

Choose "Stop, write to PM area"

If the values shown are within limits, choose "Yes" to save values to the phone.

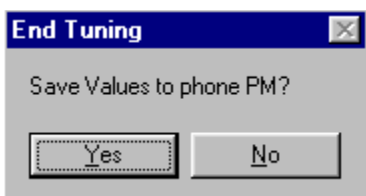

Continue tuning from GSM1900. Choose the correct band from the dropdown menu.

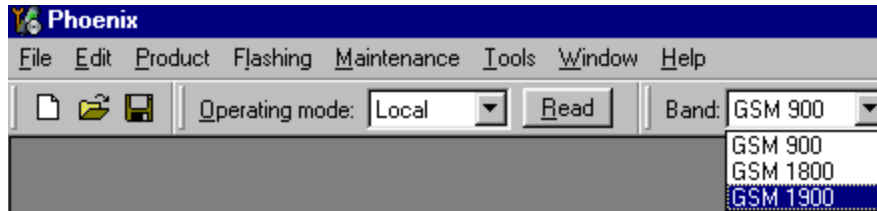

Repeat the same steps as for the EGSM900 and GSM1800 bands above.

Typical values and limits in Rx Band Filter Response Compensation GSM1900:

Channel	Input frequency (MHz)	Typ.	Low limit (dB)	High limit (dB)
496	1927.06771	-1.547	-10	3.5
512	1930.26771	-0.625	-3.5	3.5
537	1935.26771	-0.406	-3.5	3.5
586	1945.06771	0.219	-3.5	3.5
661	1960.06771	-0.188	-3.5	3.5
736	1975.06771	-0.188	-3.5	3.5
794	1986.66771	-0.75	-3.5	3.5
810	1989.86771	-0.875	-3.5	3.5
835	1994.86771	-1	-10	3.5

Choose "Stop, write to PM area"

If the values shown are within limits, choose "Yes" to save values to the phone

Close the "RX Band Filter Response Compensation" – dialog to end tuning

### RX DTOS balance calibration

Extra equipment / external RF signal not needed

Must be done separately on each band!

Start RX Calibration EGSM (GSM900), then continue at GSM1800 band and finally on the GSM1900 band

This Calibration is used for calibrating DSP control words values.

Select Maintenance => Tuning => Rx DtoS Balance Calibration

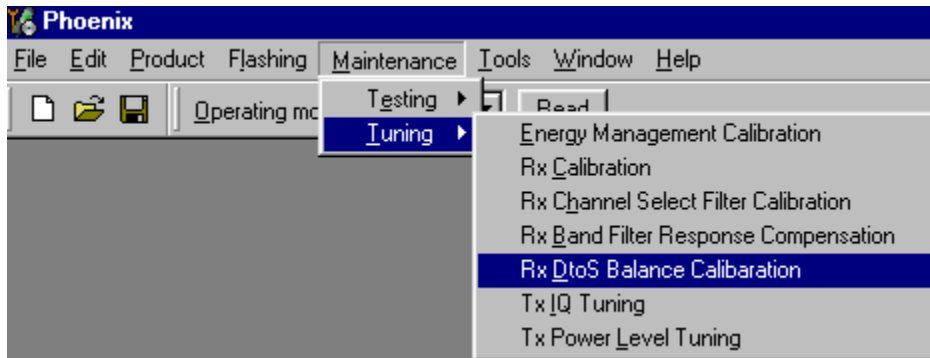

NOTE! No RF-input is allowed to feed when calibrating

Choose "OK" and "Start", tuning begins automatically at the EGSM900 band.

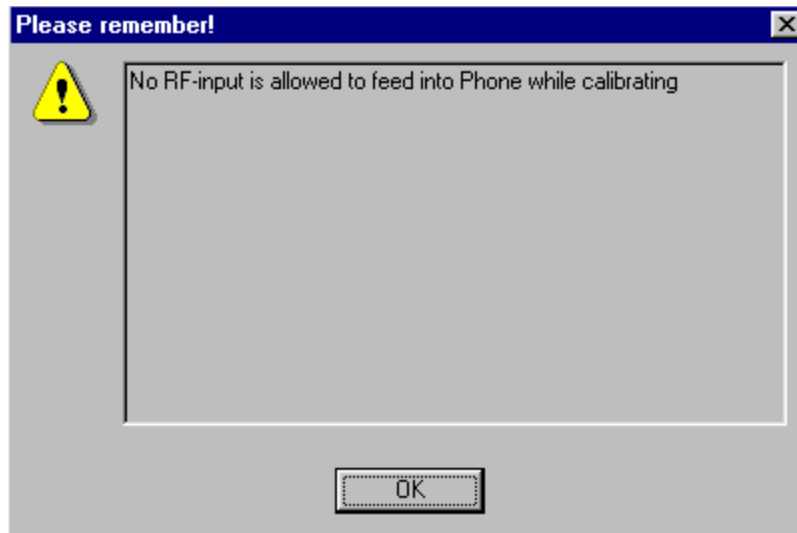

Select "OK" to start tuning with values already saved to the phone

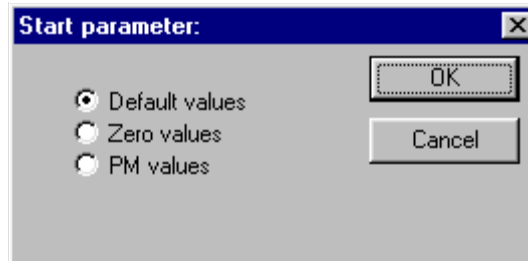

Press "Calibrate"

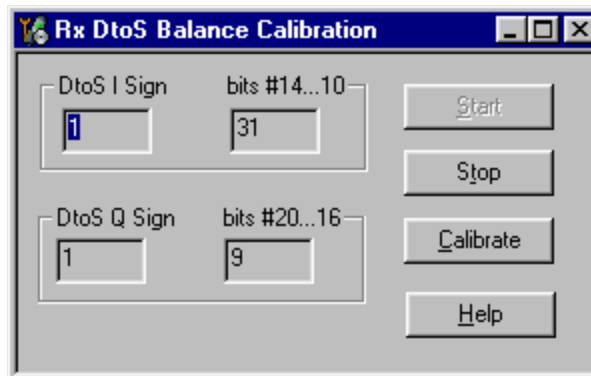

If values shown are within limits, Select "Stop" choose "Yes" to save values to the phone



**Continue tuning from GSM1800.** Choose the correct band from the dropdown menu.

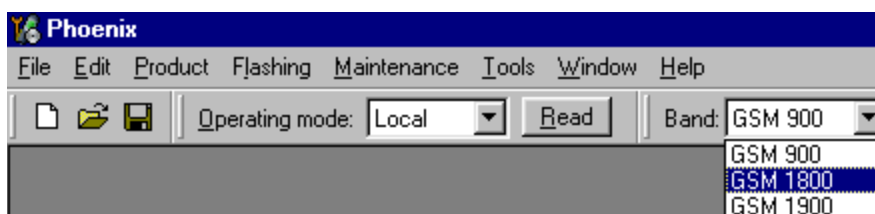

Repeat the same steps as for the EGSM900 band

If values shown are within limits, choose "Yes" to save values to the phone

Close the "RX AM Suppression" – dialog to end tuning

**Continue tuning from GSM1900.** Choose the correct band from the dropdown menu.

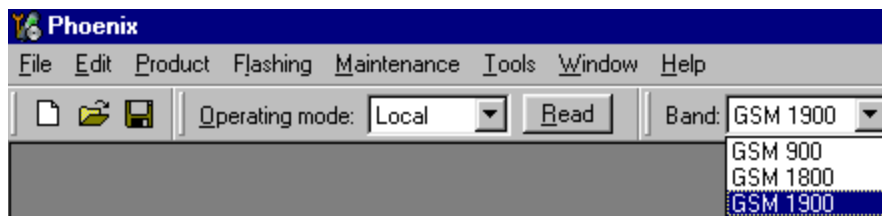

Repeat the same steps as for the EGSM900 and GSM1800 bands

If values shown are within limits, choose "Yes" to save values to the phone

Close the RX DtoS Balacce Calibration – dialog to end Receiver tuning.

## Transmitter tuning

### TX Power Level Tuning

Power Meter (or Spectrum analyzer) needed

With Tx Power Level Tuning, the coefficients are adjusted for each power level

Must be done separately on all bands!

Start Power Level tuning at EGSM (GSM900), then continue at GSM1800 band and finally at the GSM1900 band

In EGSM900 band The power level tuning is made for both high and low PA Modes

In GSM1800 and GSM1900 bands only for high PA mode.

Maintenance => Tuning => Tx power level tuning

**Remember to take the jig and cable attenuations into account!**

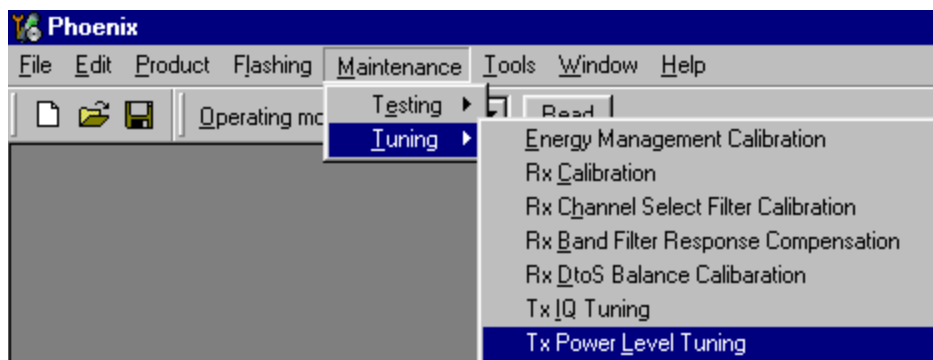

Select "Start", tuning begins automatically from the EGSM900 band

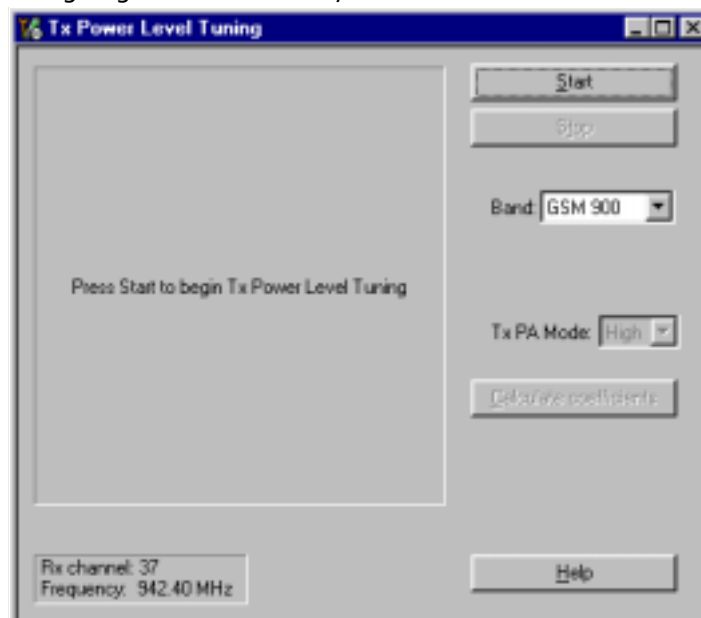



Select "Load from: Permanent memory" => "OK " to start tuning with values already saved to the phone.

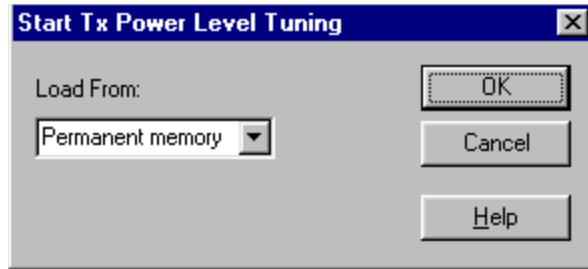

Note that the TX PA mode is "High" at this point

The coefficient table lists the power level, coefficient, target dBm and DAC value for each power level.

The tuned power level can be chosen by using up and down arrows or mouse.

The current power level is shown with inverse colors.

The tuning value can be adjusted with "-" and "+" keys

Tune base level and power levels 19,15 and 5 to target level .

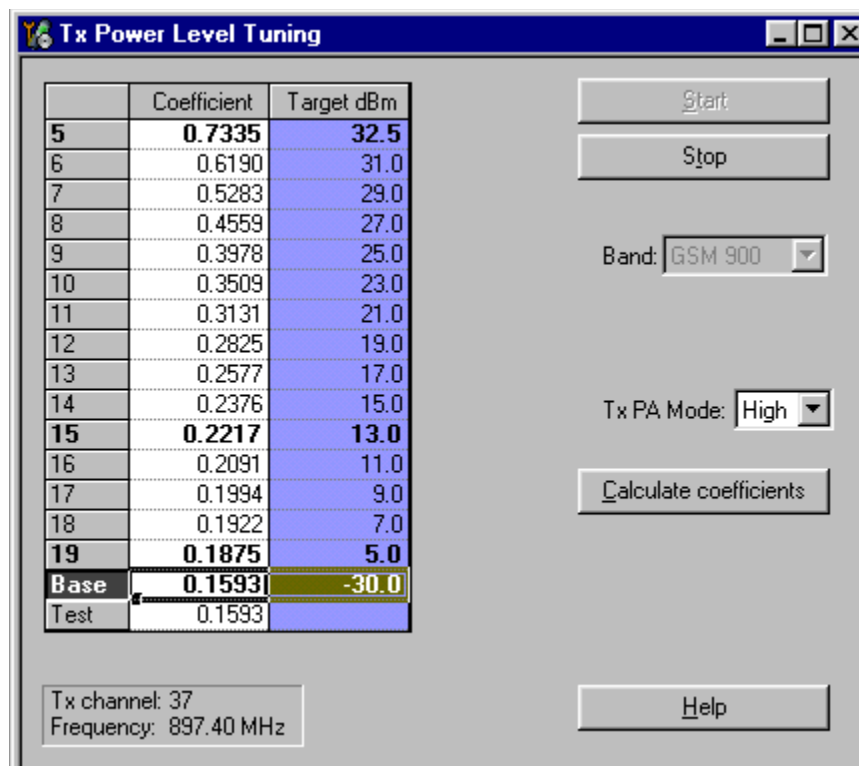

Press "Calculate coefficients".

Change TxPA Mode to "Low" from the drop down menu. When the PA Mode is changed,

the previous values are saved in memory and the ones for new mode are shown.

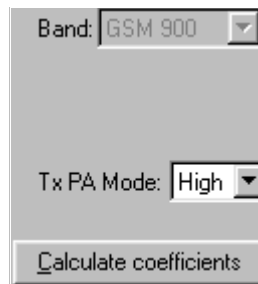

**Tune power levels 19, 15 and 7** (Levels 5 & 6 are not used, base level tuning not needed)

Press "Calculate coefficients"

**Typical values: EGSM900**

Power level	PA high mode	PA low mode
5	0.700...0.850	-
7	-	0.500...0.600
15	0.210...0.230	0.210...0.230
19	0.180...0.200	0.180...0.200
Base	0.150...0.170	0.150...0.170

If the values shown are within limits select "Stop" and check "Save values to phone permanent memory"

Select "Yes" to save values to phone.

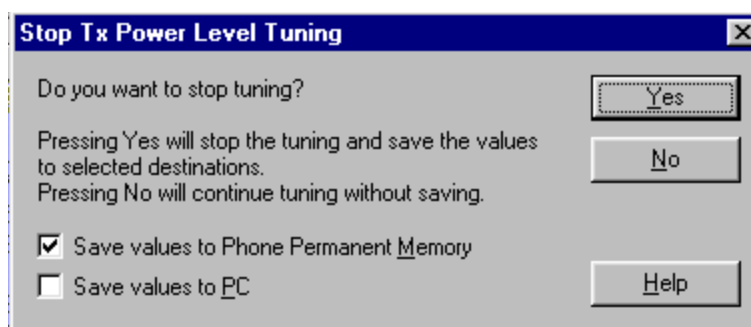

Continue tuning from GSM1800. Choose the correct band from the dropdown menu.

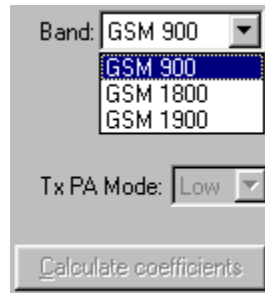

Repeat the same steps as for the EGSM900 band above

Note that In GSM1800 band PA mode can not be changed because tuning is only made in "High" mode.

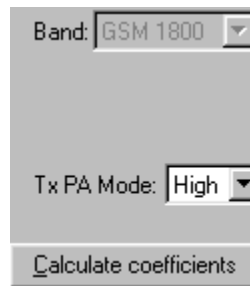

**Typical values: GSM1800**

Power level	PA high mode
0	0.700...0.900
11	0.180...0.230
15	0.150...0.200
Base	0.150...0.170

If the values shown are within limits select "Stop" and check "Save values to phone permanent memory".

Select "Yes" to save values to phone.

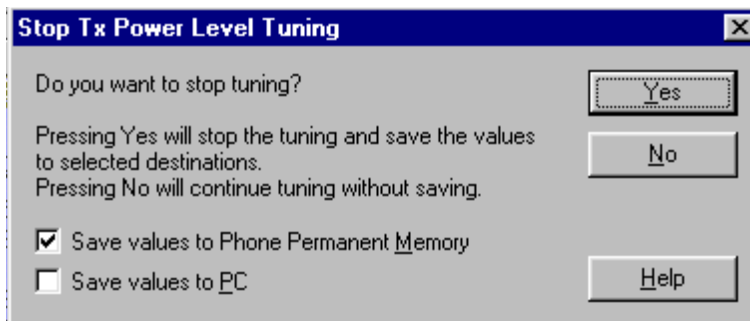

**Continue tuning from GSM1900.** Choose the correct band from the dropdown menu..

The screenshot shows a dialog box with a 'Band:' dropdown menu. The menu is open, showing three options: 'GSM 900', 'GSM 1800', and 'GSM 1900'. 'GSM 1900' is highlighted in blue. Below the menu is a 'Tx PA Mode:' dropdown menu set to 'High'. At the bottom is a button labeled 'Calculate coefficients'.

Repeat the same steps as for the EGSM900 and GSM1800 bands above

Note that In GSM1900 band PA mode can not be changed because tuning is only made in "High" mode..

The screenshot shows the same dialog box as before, but now the 'Band:' dropdown menu is closed and shows 'GSM 1900'. The 'Tx PA Mode:' dropdown menu is also closed and shows 'High'. The 'Calculate coefficients' button is still at the bottom.

#### Typical values: GSM1900

Power level	PA high mode
0	0.800...1.00
11	0.180...0.230
15	0.150...0.200
Base	0.150...0.170

If values shown are within limits select "Stop" and check "Save values to phone permanent memory"

Select "Yes" to save values to phone

Close the "TX Power Level Tuning" – dialog to end tuning

## TX I/Q Tuning

Spectrum analyzer needed

Tx IQ Tuning allows changing the Tx I DC Offset, Tx Q DC Offset, Amplitude difference and Phase difference

Must be done separately on all bands!

Start TX I/Q Tuning at EGSM (GSM900), then continue at GSM1800 band and finally on the GSM1900 band

Remember to take jig and cable attenuations into account!

Select Maintenance => Tuning => Tx\_IQTuning

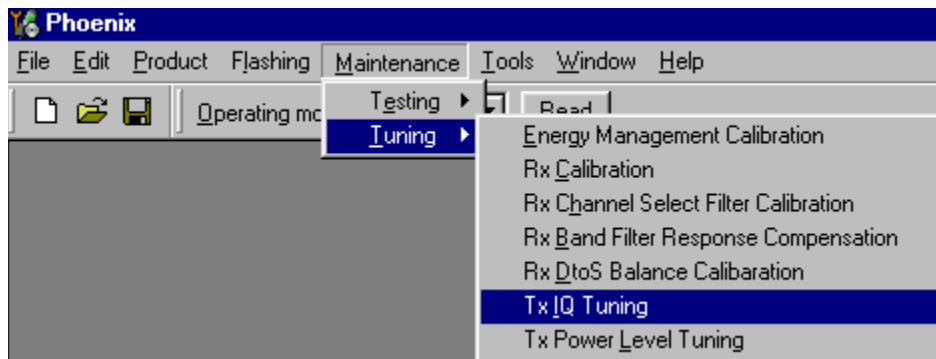

The tuning is done by setting each of the sliders to desired value.

The sliders can be changed only when the tuning is ongoing.

The order of tuning should be same as the order of the sliders e.g. the Tx I DC Offset is tuned first and Phase difference is tuned last.

Use <= , =>, PgUp or PgDn keys

If "Load from Product" is checked, the values will be loaded from the current settings of the product when tuning starts.

If "Save to Product" is checked, the values will be saved to the product when tuning stops.

Uncheck them for testing purposes.

Tx IQ Tuning limits are the same for all bands (GSM900, GSM1800 and GSM1900):

Tuning limits:	
I DC Offset	-6...+6
Q DC Offset	-6...+6
Amplitude difference	-1...+1
Phase difference	- 80°...100°

Tuning starts at the EGSM900 band automatically when you open Close the "TX I/Q Tuning" – dialog. Move the sliders to reach values within specified limits

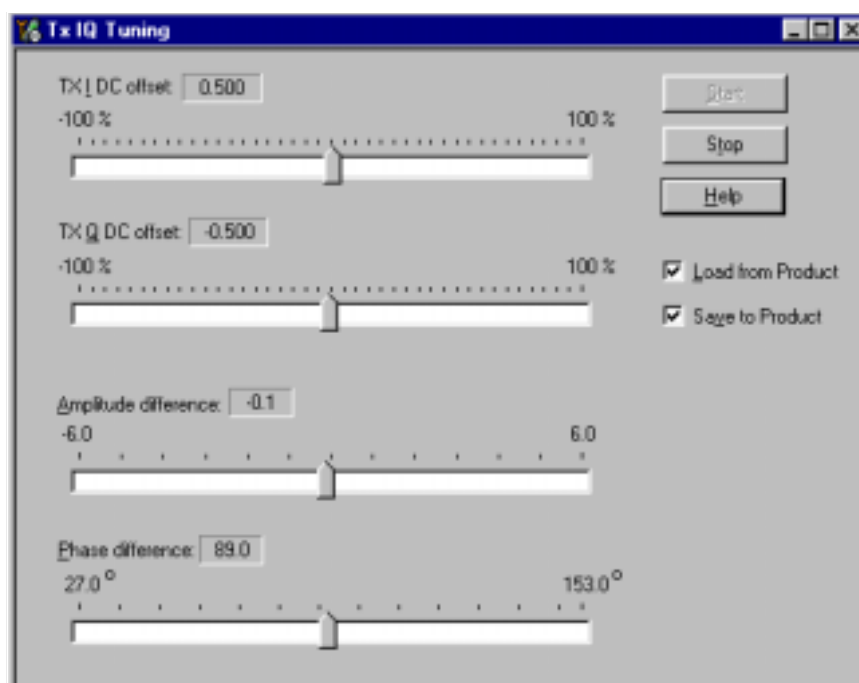

Set spectrum analyzer center frequency to 897.4 MHz, span 200kHz, RBW and VWB 3kHz and sweeptime to 2 seconds.

Tune LO leak to minimum with TXI/TXQ DC offset control (**f<sub>0</sub>** on spectrum analyzer screen)

Tune wrong sideband to minimum using Amplitude/Phase difference controls (**f<sub>0</sub>+68kHz**

on spectrum analyzer screen)

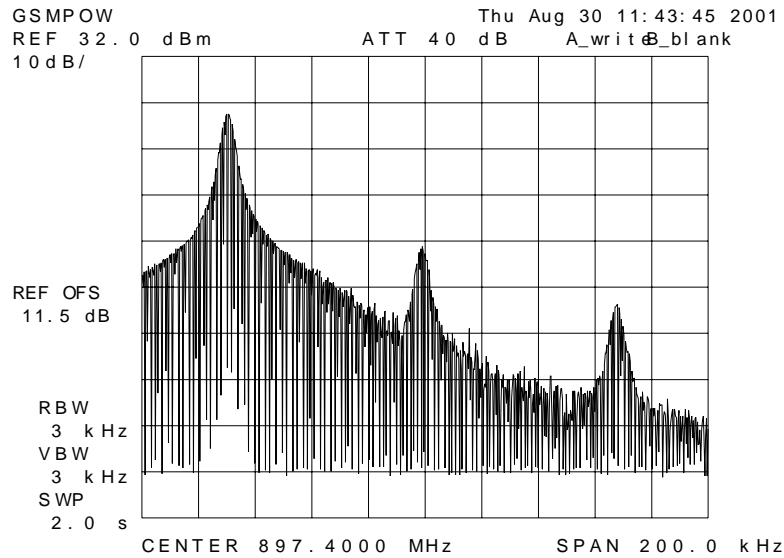

Choose "Stop" to end tuning at the EGSM900 band when vales are within limits

**Continue tuning from GSM1800.** Choose the correct band from the dropdown menu

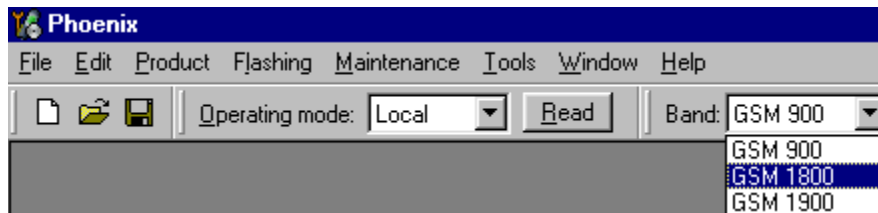

Choose "Start" to begin tuning

Repeat the same tuning steps as for the EGSM900 band

Set spectrum analyzer center frequency to 1747.8 MHz, span 200kHz, RBW and VVB 3kHz and sweeptime to 2 seconds

**Continue tuning from GSM1900.** Choose the correct band from the dropdown menu.

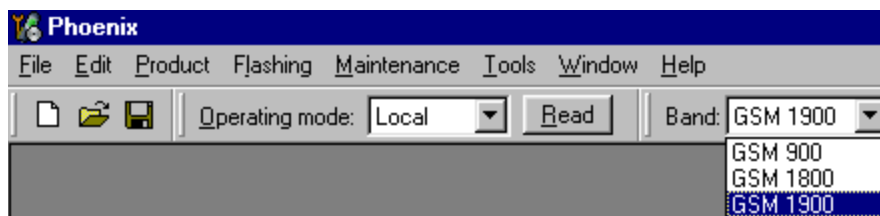

Repeat the same steps as for the EGSM900 and GSM1800 bands

Set spectrum analyzer center frequency to 1880.0 MHz, span 200kHz, RBW and VVB 3kHz and sweeptime to 2 seconds

Close the "TX I/Q Tuning" – dialog to end tuning.

Values are saved to phone if If "Save to Product" is checked.



## Service Tool Concept For Baseband Tuning Operations

EM calibrations should be carried out in JBV-1 Docking Station equipped with MJF-13 Docking Station Adapter

Note: RF tunings must be carried out in MJS-38 module jig, JBV-1

Docking Station Adapter can only be used for RF testing purposes

Power to JBV-1 should be supplied from an external DC power supply, not FPS-8 prommer

JBV-1 input voltages:

Maximum + 16 VDC

Nominal input for RF tunings is +12 V DC.

**Service Concept for NHL-4\* Baseband tunings**

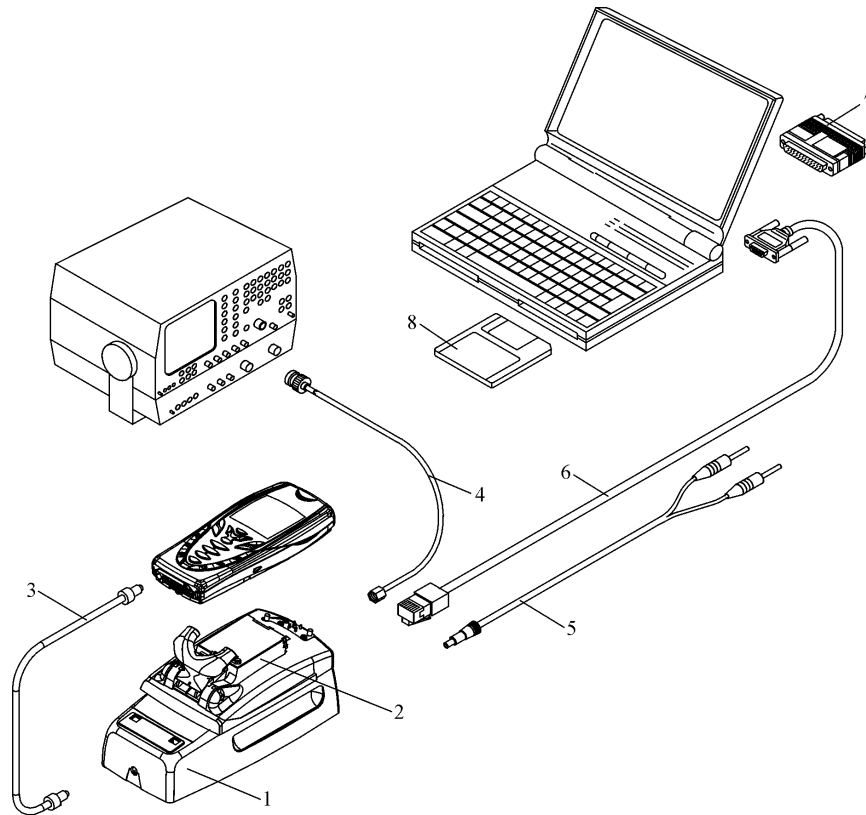

Item	Service Accessory	Accessory type	Product code
1	Docking Station	JBV-1	0770298
2	Docking Station adapter	MJF-13	0770429
4	DC-DC Cable	SCB-3	0730114
5	RF antenna cable	XRF-1	0730085
6	DC power cable	PCS-1	0730012
7	service MBUS cable	DAU-9S	0730108
8	Software protection key	PKD-1	0750018
9	Phoenix service SW		8408031
9	Phoenix service SW	CD-ROM	0774286

## Baseband Tuning operations

### Energy Management Tuning

External power supply needed.

EM Calibration is used for calibrating Battery and Charger settings of the phone.

Preparation for EM Calibration:

- Connect DC Cable SCB-3 between JBV-1 and Vin of Phone for Charger calibration.
- Connect 12...15 V from Power Supply to JBV-1.
- NOTE! Check that connection is F-BUS (does not work with M-BUS!).

Select Maintenance => Tuning => Energy Management Calibration.

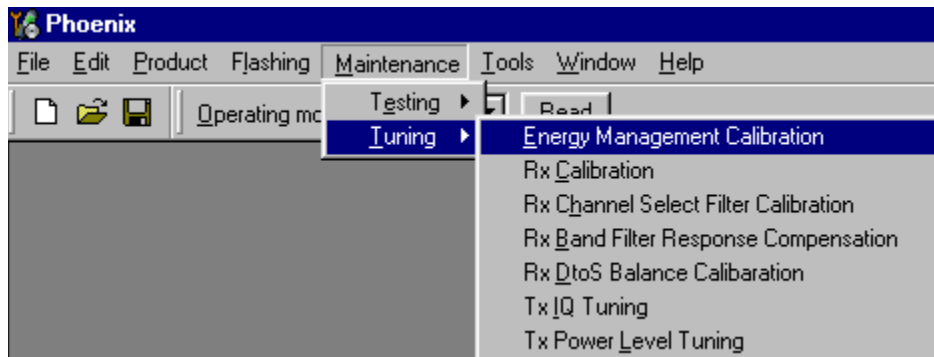

Energy Management values to be calibrated are checked.

Select "Read from Phone" to show the current values in the phone memory and to check that the communication with the phone works.

Select "Calibrate" to run the selected calibrations.

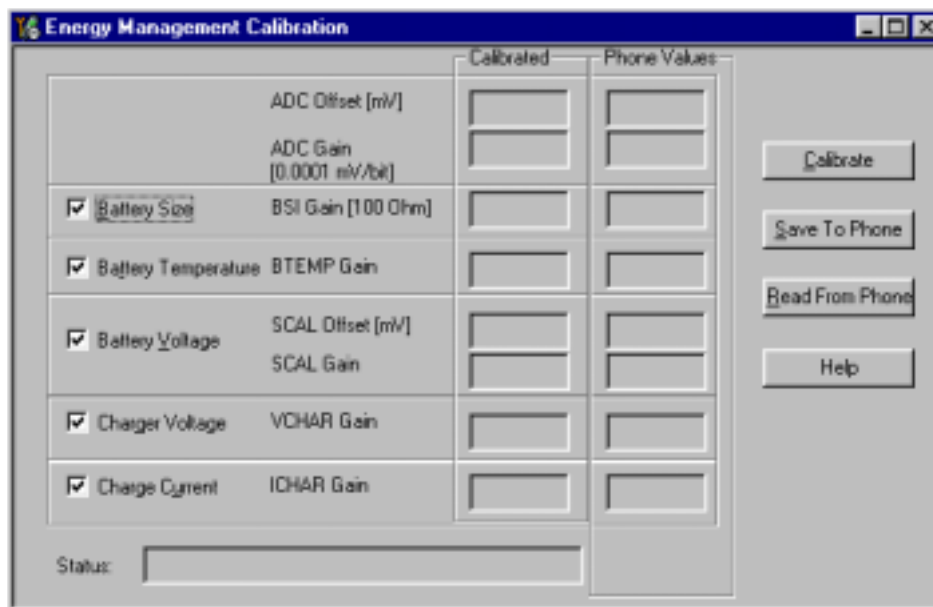

Limits for Energy Management Calibration:

Parameter	Min.	Max	Note
ADC gain	25400	29000	VBatt, BSI, BTemp
DC offset	-50	50	ADC voltage offset
BSI gain	970	1100	ADC BSI calibration gain
BTEMP gain	2075	2275	ADC BTEMP calibration gain
VBAT gain	10000	11000	ADC VBATT Voltage gain
VBAT offset	2300	2900	ADC VBATT Voltage offset scale
VCHAR	58000	62000	Charge voltage
ICHAR	4050	4800	charge current

If values shown are within limits select "Save To Phone" to save the values in the phone.

NOTE! Only the values of the checked tunings (Battery size, Battery Temperature etc...) are saved.

Close the "Energy Management Calibration" – dialog to end tuning.

You must manually switch the phone on after exiting "Energy Management Calibration" – dialog.

### LCD Contrast Tuning

Extra equipment not needed

This function is used to calibrate the LCD Contrast

**Must be done when LCD module is replaced and there is a considerable difference in the contrast!**

Select TEST mode if not already selected.

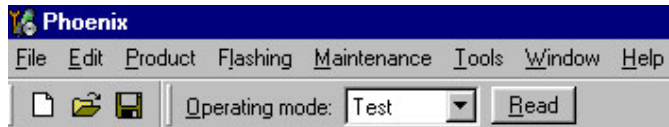

Select Maintenance => Testing => Display Test

Select Test =>Pattern test

Select Test Pattern => Chess pattern

Select Lights => Display

Select => Send To Phone.

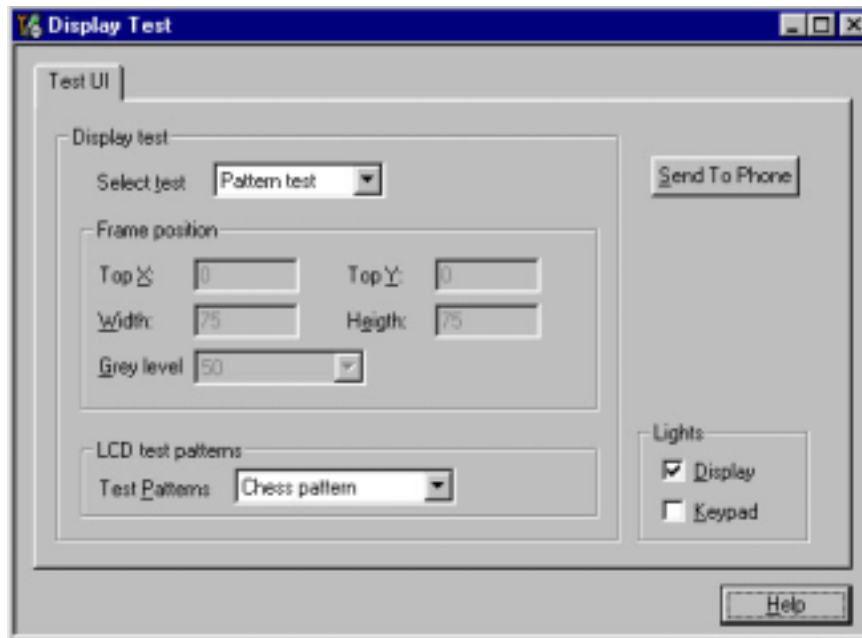

Select Maintenance => Testing => Display Tune

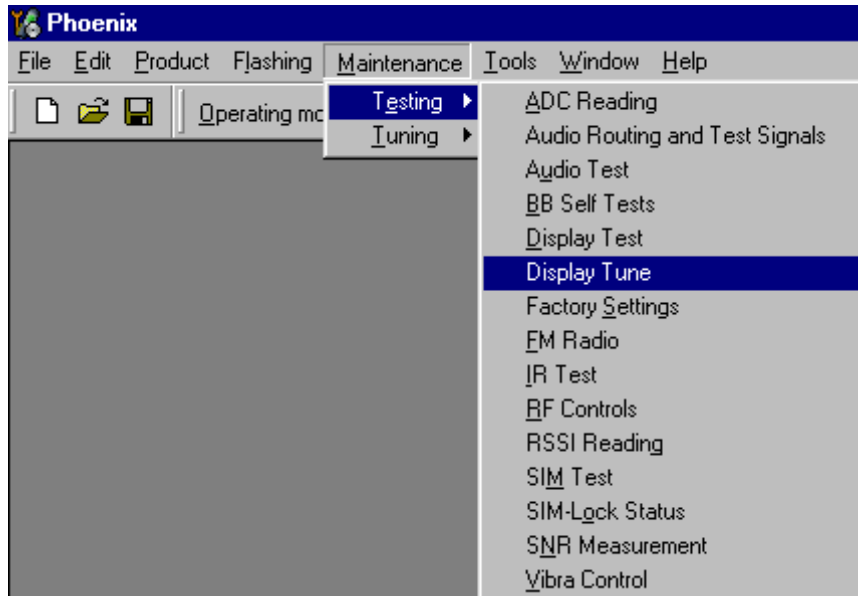

Press "Default" button and following default values will be set;

"Contrast offset slider" is set to 0% (See picture below)

"Contrast Factory offset" slider is set 41

Tune the Contrast by using "Contrast Factory offset" slider..

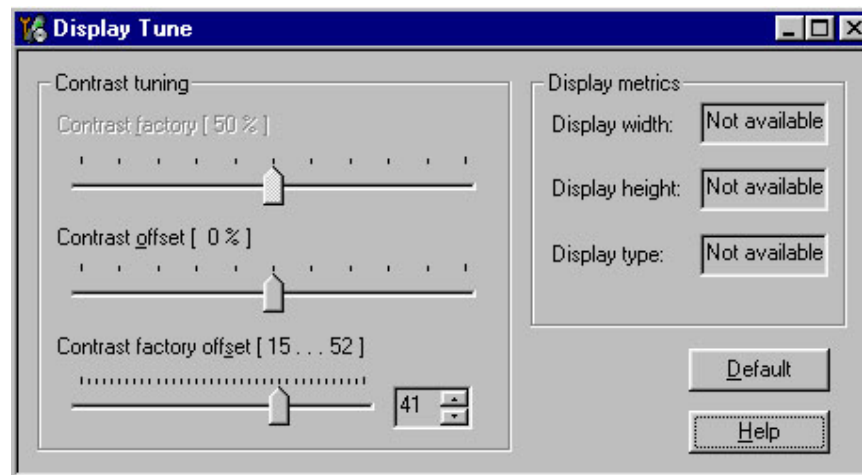

Close the "Display Tune" – dialog to end tuning.

Check the contrast from the Phone UI.

Check that the brightness has been set to default from Phone's menu 4-4-5

# Flashing Setup Instructions

## POS (Point of Sale) Flash Concept

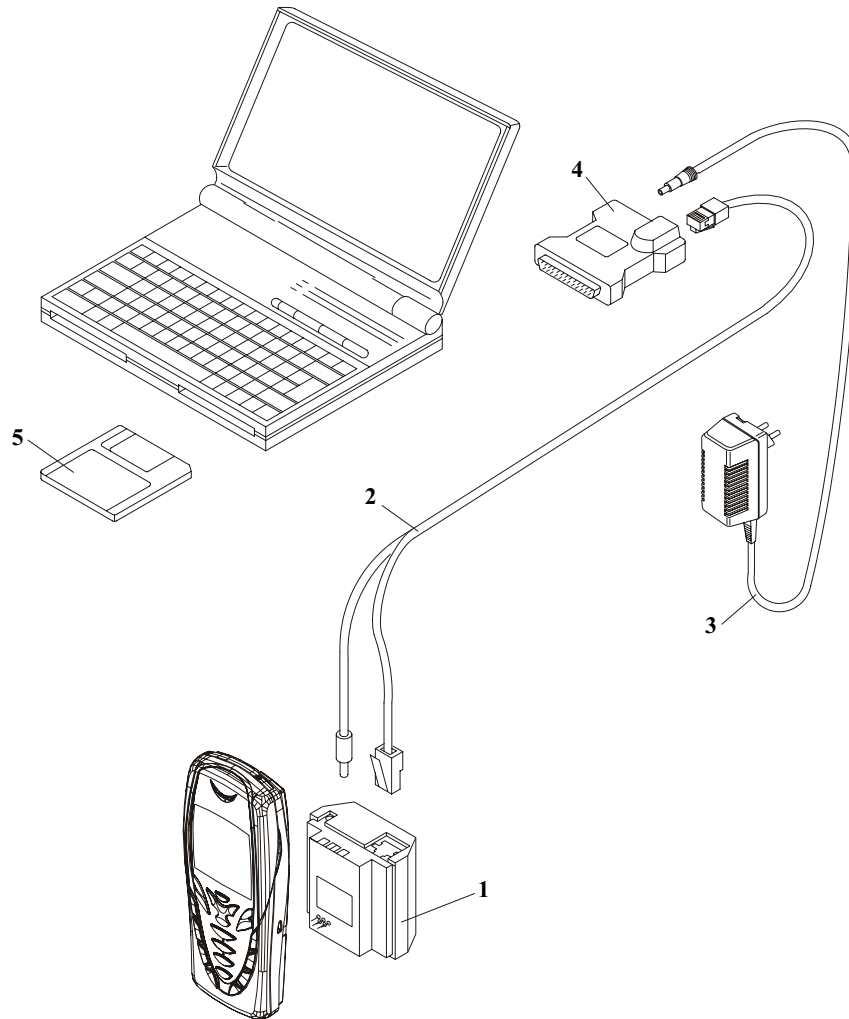
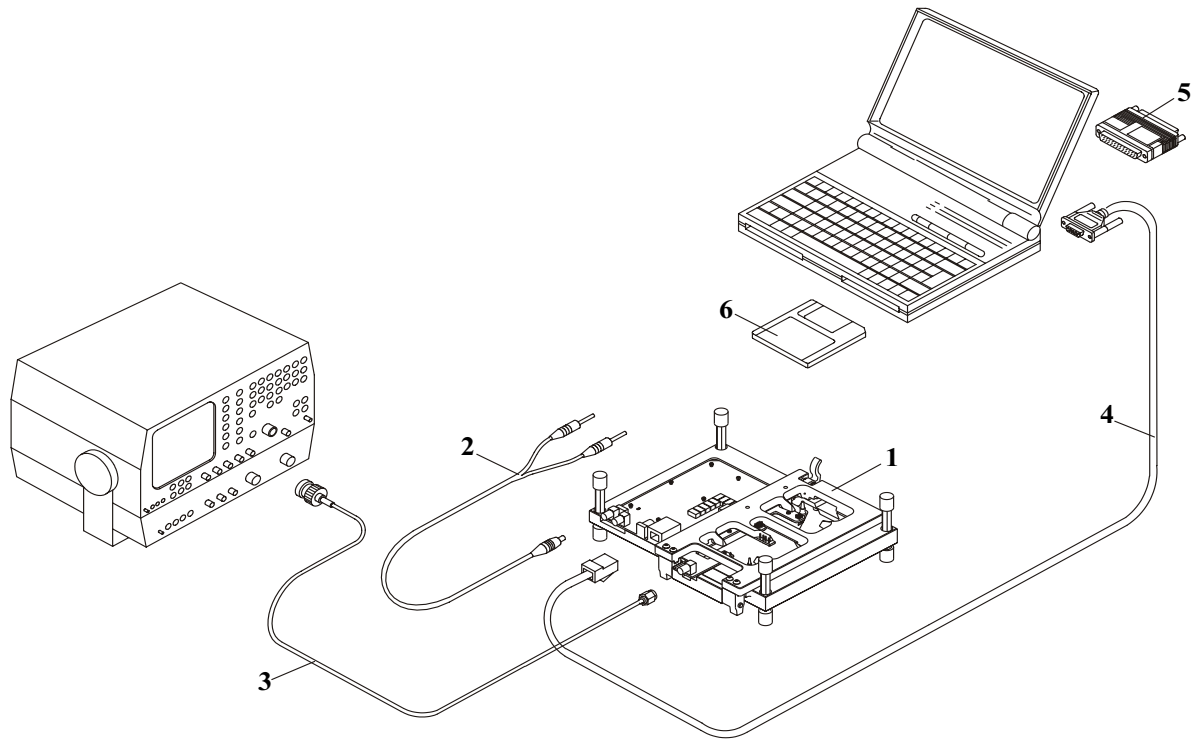

Figure 1: POS flash

Item	Type	Description	Code
	FLA-27	Point Of sales flash loading adapter	0770492
2	XCS-1	service cable	0730218
3	ACP-8	AC Charger	0675***
4	FLS-4S	FLS-4S sales package E&A	0080541
	FLS-4S,	FLS-4S sales package APAC	0080542
	FLS-4S,	FLS-4S sales package US	00805431
5	SW		

## Module Jig Concept



**Figure 2: Module jig concept**

Item	Type	Description	Code
1	MJS-38	Module jig	0770416
2	PCS-1	DC power cable	0730012
3	XRF-1	RF antenna cable	0730085
4	DAU-9S	Service MBUS cable	0730108
5	PKD-1	Software protection key	0750018
	SW	Phoenix	0774286



JBV-1 Flash Concept

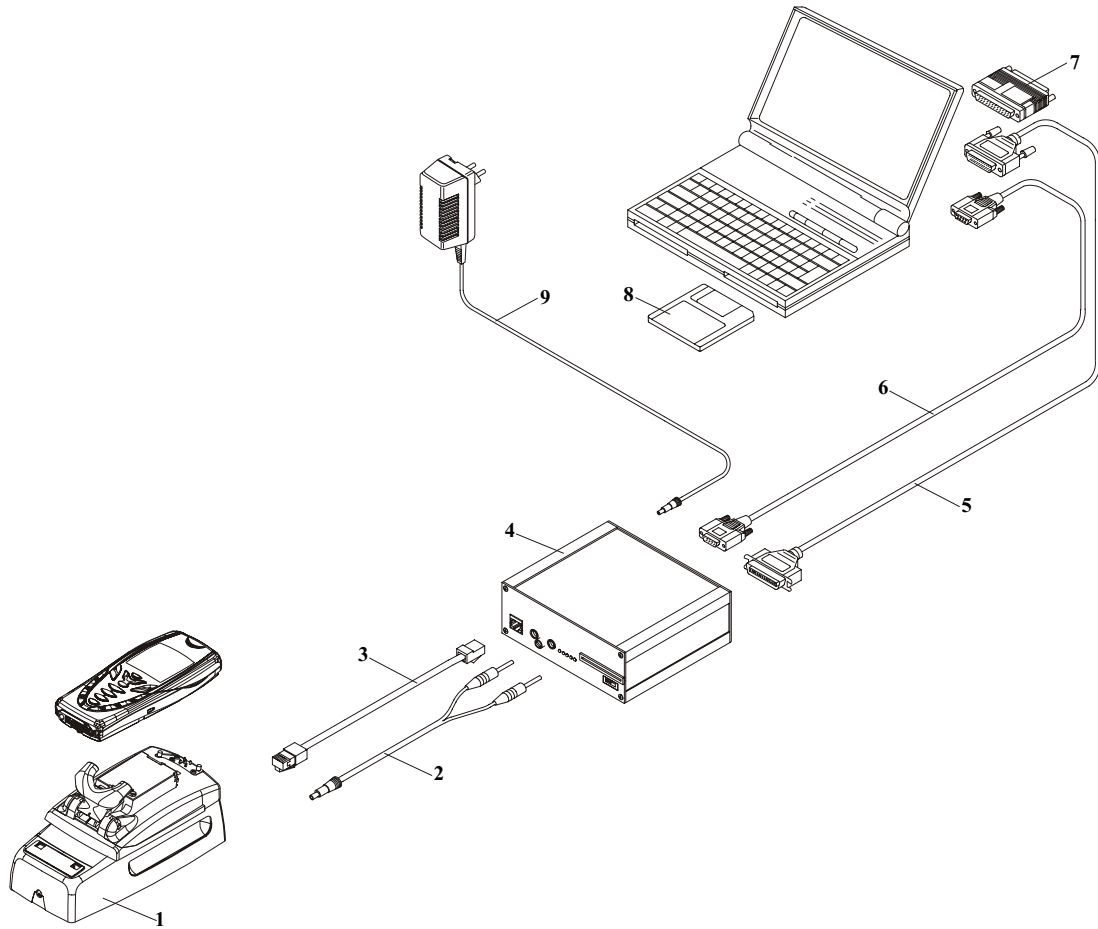
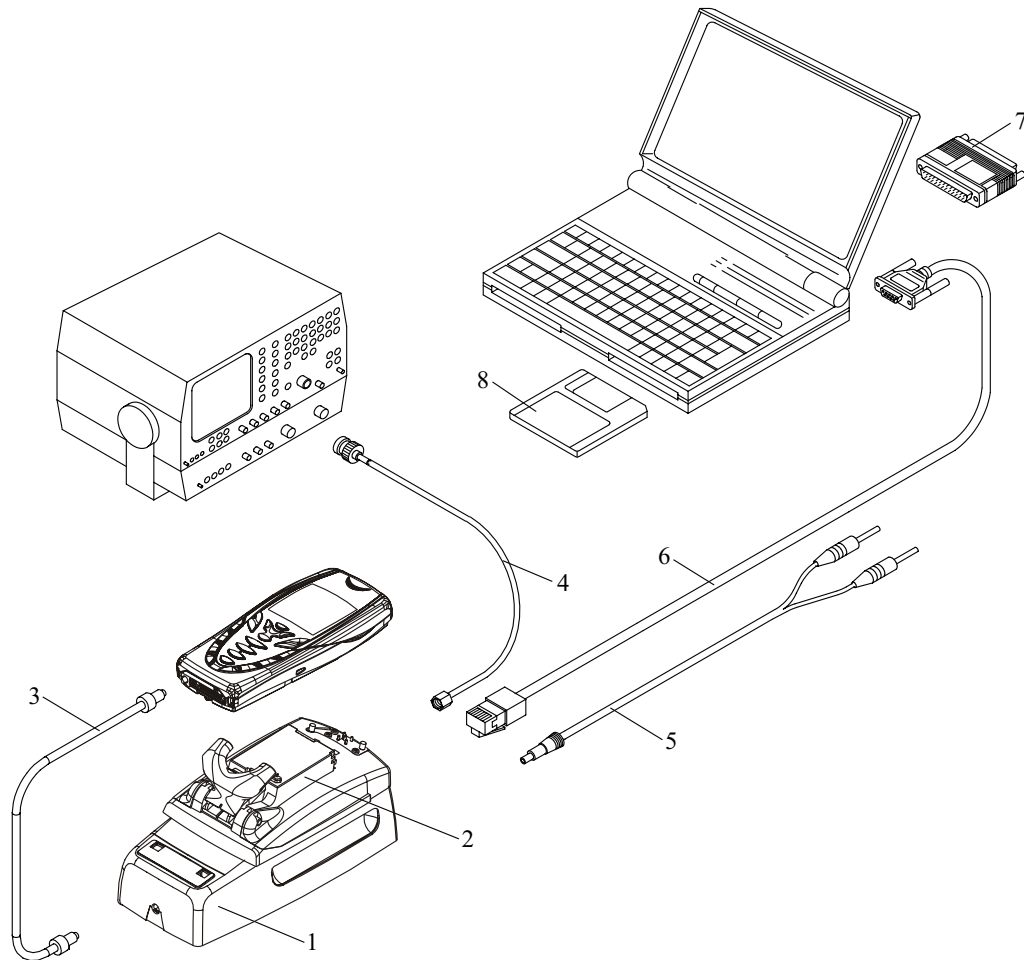

Figure 3: JBV-1 Flash concept

Item	Type	Description	Code
1	JBV-1	Docking station	0770298
	MJF-13	Docking station adapter	0770429
2	PCS-1	DC power cable	0730012
3	XCS-4	Modular cable	0730178
4	FPS-8	Flash prommer box	0080321
5	Printer cable	incl. in FPS-8 sales pack	0730029
6	AXS-4	D9 – D9 cable, incl. in FPS-8 sales pack	0730090
7	PKD-1	Software protection key	0750018
8	Service SW	Phoenix	0774286
9	AC Charger	incl. in FPS-8 sales pack	0680032

### Service Concept



**Figure 4: Service Concept**

Item:	Service accessory:	Type:	Product code:
1	Docking station	JBV-1	0770298
2	Docking station adapter	MJF-13	0770429
4	DC-DC cable	SCB-3	0730114
5	RF antenna cable	XRF-1	0730085
6	DC power cable	PCS-1	0730012
7	Service MBUS cable	DAU-9S	0730108
8	Software protection key	PKD-1	0750018
9	Phoenix Service SW		0774286
	Phoenix Service SW	CD-ROM	0775311
	NHM-4 Flash SW data		8411657
	NHM-4 Flash SW data	CD-ROM	0775313

Parallel Flash concept

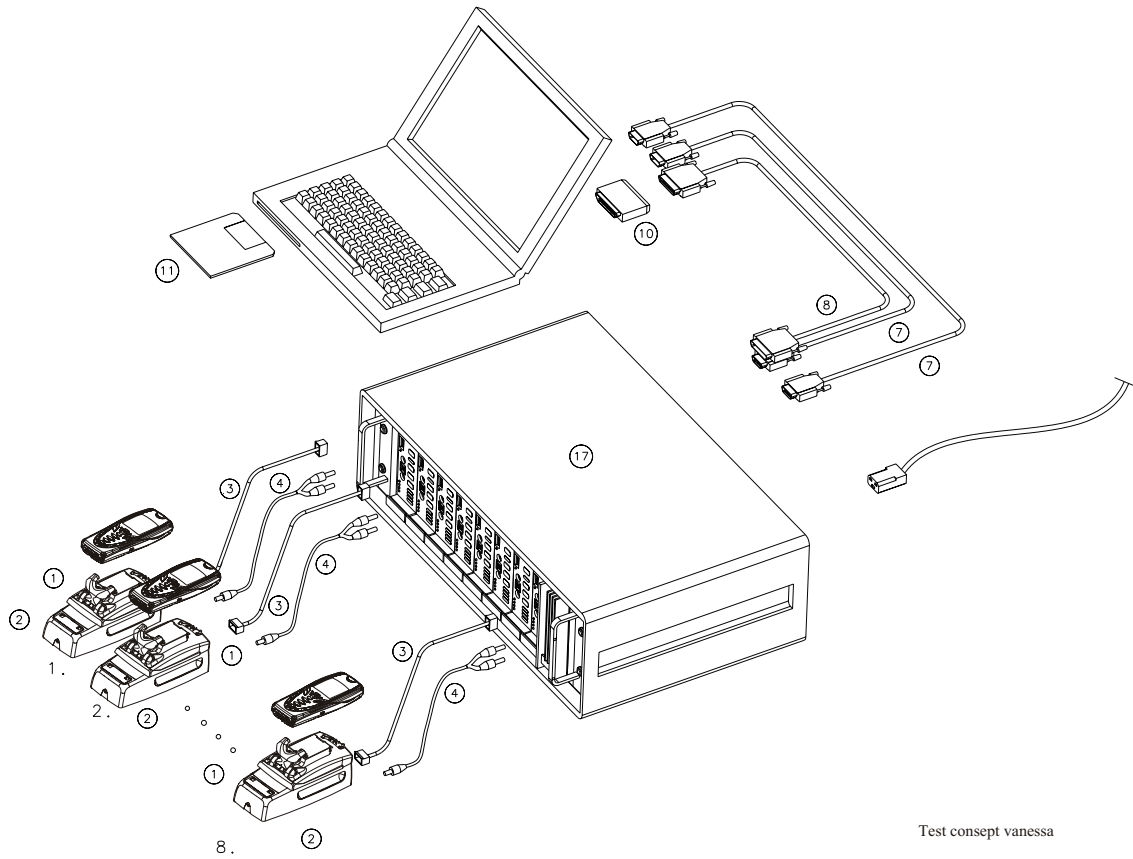

Test concept vanessa  
VP 02-06-18

Figure 5: Parallel flash concept

Item	Type	Description	Code
1	MJF-13	Docking station adapter	0770429
2	JBV-1	Docking station	0770298
3	XCS-4	Modular cable	0730178
4	PCS-1	DC power cable	0730012
7	AXS-4	D9 – D9 cable, incl. in FPS-8C sales pack	0730090
8	Printer cable	Incl. in FPS-8C sales pack	0730029
10	PKD-1	Software protection key	0750018
11	SW,	Software (PC SW + SF11C SW)	
17	FPS-8C		0080396

[This page left intentionally blank]